



## HDD AUDIO PLAYER HAP-Z1ES

### About the HDD AUDIO PLAYER

- [Features of the HDD AUDIO PLAYER \[1\]](#)
- [Playable audio file formats \[2\]](#)
- [How to make and enter selections \[3\]](#)
- [How to input characters \[4\]](#)
- [System requirements for computers connected to the HDD AUDIO PLAYER \[5\]](#)
- [Required network environment \[6\]](#)
- [Supplied accessories \[7\]](#)

### Supported applications

- [HAP Music Transfer \[8\]](#)
- [HDD Audio Remote \[9\]](#)
- [Help for HAP Music Transfer/HDD Audio Remote \[10\]](#)

### Preparations

- [What you need to do before starting to use the HDD AUDIO PLAYER \[11\]](#)
- [Prep 1. Connecting an amplifier \[12\]](#)
- [Prep 2. Connecting to a network with a LAN cable \(only when using a wired LAN\) \[13\]](#)
- [Prep 3. Turning on the HDD AUDIO PLAYER \[14\]](#)
- [Prep 4. Configuring the initial settings of the HDD AUDIO PLAYER \[15\]](#)
- [Prep 5. Configuring the settings of a computer to use HAP Music Transfer \[16\]](#)
- [Operating the HDD AUDIO PLAYER from your smartphone or tablet \(using HDD Audio Remote\) \[17\]](#)
- [Preparing the remote control \[18\]](#)

### Connections

- [Connecting to a computer \[19\]](#)
- [Connecting an amplifier \[20\]](#)
- [Connecting an external hard disk drive \[21\]](#)

## **Network connections (wired LAN)**

- [Required network environment \[22\]](#)
- [Connecting the HDD AUDIO PLAYER to a network automatically \[23\]](#)
- [Connecting the HDD AUDIO PLAYER to a network manually \[24\]](#)

## **Wi-Fi network connections (wireless LAN)**

- [Required network environment \[25\]](#)
- [Selecting a Wi-Fi \(wireless LAN\) connection method \[26\]](#)
- [Method 1. Setting up a network connection using the WPS push button configuration method \[27\]](#)
- [Method 2. Setting up a network connection by selecting an access point \[28\]](#)
- [Method 3. Setting up a network connection by adding a new access point \[29\]](#)
- [Method 4. Setting up a network connection using the \(WPS\) PIN code configuration method \[30\]](#)

## **Playing music**

- [Playable audio file formats \[31\]](#)
- [Transferring music files from a computer to the HDD AUDIO PLAYER \[32\]](#)
- [Playing music files \[33\]](#)
- [Deleting music files from the HDD AUDIO PLAYER \(when operating on the HDD AUDIO PLAYER\) \[34\]](#)
- [Deleting music files from the HDD AUDIO PLAYER \(when using the HAP Music Transfer\) \[35\]](#)
- [Playing tracks using SensMe™ channels \[36\]](#)
- [Playing tracks in playlists \[37\]](#)
- [Selecting playback methods \[38\]](#)
- [Registered music file information \[39\]](#)
- [Standby modes \[40\]](#)

## Internet radio

- [Listening to the TuneIn Internet radio programs \[41\]](#)
- [Listening to the vTuner Internet radio programs \[42\]](#)

## Useful functions

- [Deleting music files from the HDD AUDIO PLAYER \(when operating on the HDD AUDIO PLAYER\) \[43\]](#)
- [Deleting music files from the HDD AUDIO PLAYER \(when using the HAP Music Transfer\) \[44\]](#)
- [Using the DSEE function \[45\]](#)
- [Adding tracks to “Favorites” \[46\]](#)
- [Playing tracks in “Favorites” \[47\]](#)
- [Operating an external amplifier using the remote control or the dedicated application \[48\]](#)
- [Registered music file information \[49\]](#)

## Parts and controls

- [Front panel \[50\]](#)
- [Rear panel \[51\]](#)
- [Remote control \[52\]](#)
- [Home screen \[53\]](#)
- [Playback screen \[54\]](#)
- [Playback Options screen \[55\]](#)
- [Play Queue screen \[56\]](#)

## Settings menus

- [Network Settings \[57\]](#)
- [HDD Settings \[58\]](#)
- [Audio Settings \[59\]](#)
- [Amp Control Settings \[60\]](#)
- [System Settings \[61\]](#)
- [Network Update \[62\]](#)

## Backups

- [Backing up data \[63\]](#)
- [Backing up music files in the HDD AUDIO PLAYER to your computer \(for Windows\) \[64\]](#)
- [Backing up music files in the HDD AUDIO PLAYER to your computer \(for Mac\) \[65\]](#)
- [Returning backup music files from your computer to the HDD AUDIO PLAYER \(for Windows\) \[66\]](#)
- [Returning backup music files from your computer to the HDD AUDIO PLAYER \(for Mac\) \[67\]](#)

## Specifications/Notes

- [Playable audio file formats \[68\]](#)
- [Design and specifications \[69\]](#)
- [Software updates for the HDD AUDIO PLAYER \[70\]](#)
- [When registering music files to the HDD AUDIO PLAYER \[71\]](#)
- [Precautions on heat buildup \[72\]](#)
- [Notes on the internal hard disk drive \[73\]](#)
- [Precautions for use \[74\]](#)
- [Trademarks \[75\]](#)

## Troubleshooting

- [General \[76\]](#)
- [Sound/playback \[77\]](#)
- [Connections \[78\]](#)
- [Hard disk drive \[79\]](#)
- [Help for HAP Music Transfer/HDD Audio Remote \[80\]](#)
- [If the problem is not solved \[81\]](#)

## Dealing with problems/Inquiries

- [Standby modes \[82\]](#)
- [Forced shutdown of the HDD AUDIO PLAYER \[83\]](#)
- [Messages for protecting the HDD AUDIO PLAYER \[84\]](#)
- [Other messages \[85\]](#)

- When a notification about a new version of the software appears on the display [86]
- Customer support websites [87]

---

[1] About the HDD AUDIO PLAYER

## Features of the HDD AUDIO PLAYER

---

Thank you for purchasing this HDD AUDIO PLAYER.

The HDD AUDIO PLAYER is a music player that allows you to transfer and store High-Resolution Audio files, such as DSD, and various other formats of audio files, such as MP3 and FLAC, from your computer and enjoy playback of high quality audio sources.

You can install a specially designed application on your smartphone or tablet and operate the HDD AUDIO PLAYER remotely.

The HDD AUDIO PLAYER has the following features:

### Transferring various audio files to the HDD AUDIO PLAYER



You can transfer various types of audio files to the hard disk drive of the HDD AUDIO PLAYER from a computer connected to the same network (\*).

Storing audio files in the HDD AUDIO PLAYER allows you to enjoy high quality sound playback that is not affected by the network environment.

\* You can use HAP Music Transfer, an application designed for HDD AUDIO PLAYER, to automatically transfer audio files from your computer to the HDD AUDIO PLAYER.

### High quality audio playback



The HDD AUDIO PLAYER can play High-Resolution Audio files such as 192 kHz/24 bit, 96 kHz/24 bit, or DSD (Direct Stream Digital) audio files.

Furthermore, the HDD AUDIO PLAYER gives a more natural and expansive sound to

compressed audio files, such as MP3s, by restoring high-frequency sound and almost imperceptible sound during fade-out, which are usually lost by compression.

## Easy operation with your smartphone or tablet

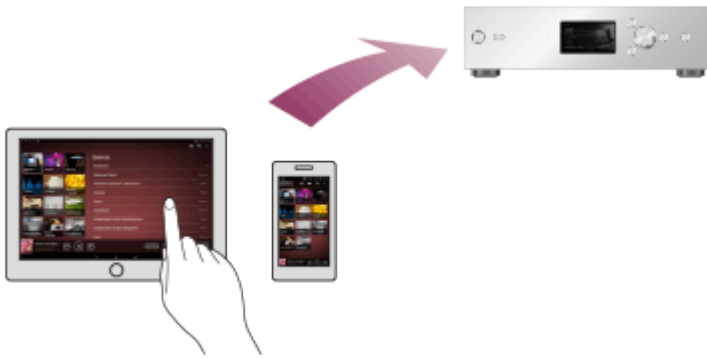

The HDD Audio Remote application is available to for even easier operation of the HDD AUDIO PLAYER.

You can install the application on your smartphone or tablet.

---

[2] About the HDD AUDIO PLAYER

## Playable audio file formats

---

The following audio file formats can be played on the HDD AUDIO PLAYER.

### **DSD (DSF, DSDIFF)**

Extensions: .dsf, .diff

Sampling frequency: 2.8224 MHz, 5.6448 MHz

### **LPCM (WAV, AIFF)**

Extensions: .wav, .aif, .aiff

Sampling frequency: 44.1 kHz, 48 kHz, 88.2 kHz, 96 kHz, 176.4 kHz, 192 kHz

Quantization bits: 16 bits, 24 bits, 32 bits (\*)

\* 32-bit playback is only possible for files in WAV format.

### **FLAC**

Extensions: .flac, .fla

Sampling frequency: 44.1 kHz, 48 kHz, 88.2 kHz, 96 kHz, 176.4 kHz, 192 kHz

Quantization bits: 16 bits, 24 bits

### **ALAC**

Extensions: .m4a

Sampling frequency: 44.1 kHz, 48 kHz, 88.2 kHz, 96 kHz, 176.4 kHz, 192 kHz

Quantization bits: 16 bits, 24 bits

### **MP3 (MPEG-1/2 Audio Layer-3)**

Extensions: .mp3

Bit rate: 64 kbps - 320 kbps

Sampling frequency: 44.1 kHz, 48 kHz

Quantization bits: 16 bits

### **AAC (MPEG-4 AAC-LC, HE-AAC)**

Extensions: .m4a, .mp4, .3gp

Bit rate: 64 kbps - 320 kbps

Sampling frequency: 44.1 kHz, 48 kHz

Quantization bits: 16 bits

### **WMA (WMA, WMAPro, WMA Lossless)**

Extensions: .wma, .asf

Bit rate: 32 kbps - 320 kbps (WMA, WMAPro)

Sampling frequency: 44.1 kHz, 48 kHz (WMA)

Sampling frequency: 44.1 kHz, 48 kHz, 88.2 kHz, 96 kHz (WMAPro, WMA Lossless)

Quantization bits: 16 bits (WMA, WMAPro)

Quantization bits: 16 bits, 24 bits (WMA Lossless)

### **ATRAC (ATRAC3, ATRAC3plus, ATRAC Advanced Lossless)**

Extensions: .oma, .aa3

Bit rate: 48 kbps - 352 kbps (ATRAC3plus)

Bit rate: 132 kbps (ATRAC3)

Sampling frequency: 44.1 kHz

Quantization bits: 16 bits

#### **Note**

- No copy protected files in any of the above formats can be played. If you transfer copy protected files to the HDD AUDIO PLAYER, music information of the copy protected files will appear in gray and you will not be able to select it.
- Only 2ch files in the above formats are supported.
- Playing formats other than those above may produce noise or even damage the speakers if played at a high volume.

---

[3] About the HDD AUDIO PLAYER

## How to make and enter selections

---

The basic operations of the HDD AUDIO PLAYER are as follows:



1. Turn the jog dial left or right to select an item.
2. Press ENTER to enter the selection.

#### Hint

- To display the Home screen, press the HOME button.
- To go back to the previous screen, press the BACK button.

---

#### [4] About the HDD AUDIO PLAYER

### How to input characters

---

When the character input screen appears during operations, enter characters as follows:



A: Character input area

B: Keyboard area

C: OK

1. Turn the jog dial left or right to select a character in the keyboard area, and then press ENTER to enter the selection.
2. Repeat the operations in step 1 to enter a text string.



3. When the character input is done, turn the jog dial left or right to select [OK], and then press ENTER.

#### Hint

- To change the type of characters, use the character type selection button on the bottom left of the keyboard area.  
The character type changes in the order of [ABC] (capitals), [abc] (lower case) and [@./] (symbols).
- To move the cursor left and right in the character input area, use ←/→.
- To delete a character, move the cursor to the right of the character you want to delete, and then use [BS] on the keyboard area.

---

[5] About the HDD AUDIO PLAYER

## System requirements for computers connected to the HDD AUDIO PLAYER

---

HAP Music Transfer, an application that copies audio files from your computer to the HDD AUDIO PLAYER, can be used in the following system environment:

### OS

- Windows 8.1
- Windows 8
- Windows 8 Pro
- Windows 7 Starter Service Pack 1 or later
- Windows 7 Home Basic Service Pack 1 or later
- Windows 7 Home Premium Service Pack 1 or later
- Windows 7 Professional Service Pack 1 or later
- Windows 7 Ultimate Service Pack 1 or later
- Windows Vista Home Basic Service Pack 2 or later
- Windows Vista Home Premium Service Pack 2 or later
- Windows Vista Business Service Pack 2 or later
- Windows Vista Ultimate Service Pack 2 or later
- Mac OS X 10.6, 10.7, 10.8, 10.9, 10.10 (\*)

\* Intel CPU models, 64 bit (10.6, 10.7, 10.8, 10.9, 10.10) and 32 bit (10.6, 10.7) are supported.

### Screen resolution

1,024 x 768 pixels or higher

**Note**

- One of the above operating systems should be installed by default. Upgraded operating systems and multi-boot environments are not supported.
  - We do not guarantee operation for all computers even if they meet the above system requirements. Furthermore, the following systems are not supported:
    - Personally constructed computers or operating systems
    - Upgraded operating systems
    - Multi-boot environments
    - Multi-monitor environments
- 

[6] About the HDD AUDIO PLAYER

## Required network environment

---

You can transfer audio files from your computer to the HDD AUDIO PLAYER by connecting both to the same network, either by a wired or wireless connection.

Confirm the supported environment described below.

**Note**

- You need to connect the HDD AUDIO PLAYER to a network that can access the Internet if you want to listen to Internet radio programs.

### Wired LAN (using a LAN cable)

#### LAN (10/100/1000) port:

1000BASE-T/100BASE-TX/10BASE-T

(The network speed may differ depending on the network environment.)

#### LAN cable:

- We recommend using a LAN cable that is Cat5 or higher. A normal-type cable is also recommended, as some flat-type LAN cables are easily affected by noise.
- If the receiver is used in an environment with power supply noise from electronic devices or in a noisy network environment, use a shielded-type LAN cable.

### Wi-Fi (using a wireless LAN network)

#### Compatible standards:

IEEE 802.11 b/g/n

#### Security mode:

None

WEP

WPA/WPA2-PSK (AES)

WPA/WPA2-PSK (TKIP)

## Radio frequency:

2.4 GHz

### Note

- Wi-Fi devices work on the 2.4 GHz band, which is used by a variety of devices. Wi-Fi devices use technology to minimize radio interference from other devices that use the same band. However, radio interference may still cause slower data transfer rates, reduce the communication range, or cause communication failure.
- The data transfer rate and communication range may vary depending on the following conditions:
  - Distance between devices
  - Presence of obstacles between devices
  - Device configuration
  - Signal conditions
  - Surrounding environment (wall material, etc.)
  - Software in use
- Communications may be cut off depending on signal conditions.
- The HDD AUDIO PLAYER does not support 5 GHz band Wi-Fi.
- The data transfer rate for IEEE 802.11g and IEEE 802.11n (2.4 GHz) devices may be affected by interference when used with IEEE 802.11b products. Also, products using IEEE 802.11g and IEEE 802.11n automatically lower the transfer rate to maintain compatibility with IEEE 802.11b products. The normal transfer rate may be regained by changing the channel settings of your access point.
- When the data transfer rate is not as fast as expected, changing the wireless channel on the access point may increase the rate.
- If a communication failure occurs while transferring music files, updating the firmware of your access point may improve the communication status.

---

[7] About the HDD AUDIO PLAYER

## Supplied accessories

---

Main unit (1)

Remote control (1)

R03 (size-AAA) batteries (2)

AC power cord (mains lead) (1)

LAN cable (1)

Audio cord (1)

IR blaster (1)

[8] Supported applications

## HAP Music Transfer

---

### What you can do using HAP Music Transfer

You can transfer audio files managed and stored on your computer to the HDD AUDIO PLAYER using the dedicated HAP Music Transfer application.

Install the application to your (Windows or Mac) computer.

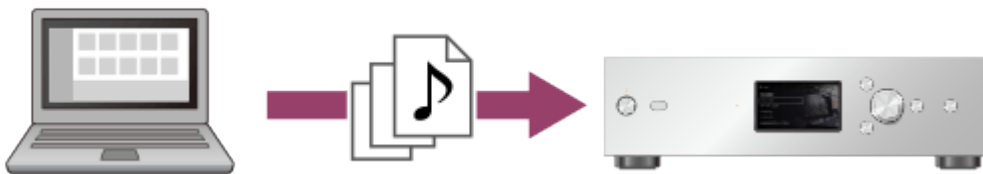

### Downloading HAP Music Transfer

Download HAP Music Transfer from the following website:

**Models for the USA and Canada:**

<http://esupport.sony.com/swu/8811>

**Models for Europe:**

[www.sony.eu/support](http://www.sony.eu/support)

---

[9] Supported applications

## HDD Audio Remote

---

### What you can do using HDD Audio Remote

You can operate the HDD AUDIO PLAYER using your smartphone or tablet by installing HDD Audio Remote, a dedicated application for smartphones and tablets.

HDD Audio Remote allows you to browse and play audio files stored in the HDD AUDIO PLAYER from your smartphone or tablet.

You can also add tracks to playlists, edit information such as the genre, artist, album and track title of music files, and more.

Install the application to your smartphone or tablet.

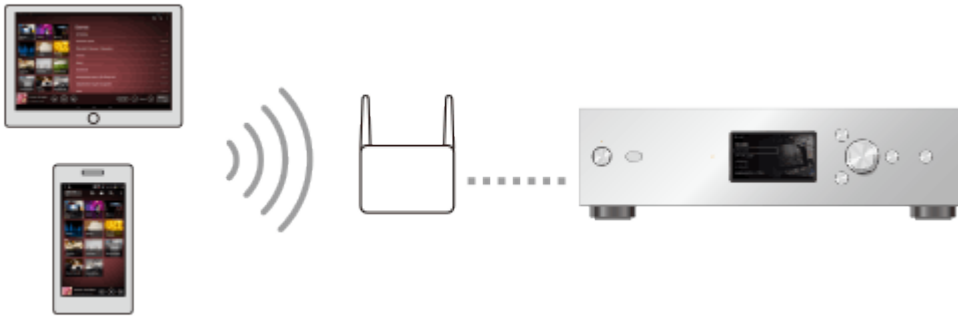

---

## Downloading HDD Audio Remote

Download HDD Audio Remote from the following websites:

- For Android devices: Google Play
- For iPhone/iPod touch/iPad: App Store

---

[10] Supported applications

## Help for HAP Music Transfer/HDD Audio Remote

---

Help for HAP Music Transfer or HDD Audio Remote can be displayed from the following website.

<http://rd1.sony.net/help/ha/hap1/>

---

[11] Preparations

## What you need to do before starting to use the HDD AUDIO PLAYER

---

After you purchase the HDD AUDIO PLAYER, you need to connect the external equipment and configure settings before you can listen to music.

1. Prep 1. Connecting an amplifier.
2. Prep 2. Connecting to a network with a LAN cable (only when using a wired LAN).  
Make a wired connection between the HDD AUDIO PLAYER and a computer with a LAN cable (supplied).  
If you want to establish a wireless connection between the HDD AUDIO PLAYER and computer, you can set it in step 4.
3. Prep 3. Turning on the HDD AUDIO PLAYER.

When all necessary connections are completed, AC power cord (mains lead) to the wall outlet (mains) and then turn the power on.

4. Prep 4. Configuring the initial settings of the HDD AUDIO PLAYER.

When you use the HDD AUDIO PLAYER for the first time, configure the language setting and network setting first.

5. Prep 5. Configuring the settings of a computer to use HAP Music Transfer.

Install HAP Music Transfer on your computer.

HAP Music Transfer is a dedicated application to transfer music files stored on your computer to the HDD AUDIO PLAYER.

6. Launch HAP Music Transfer to transfer music files on your computer to the HDD AUDIO PLAYER.

Refer to the HAP Music Transfer Help for details on operations.

7. Play music files transferred to the HDD AUDIO PLAYER.

Choose your desired method of playback from each topic under “Playing music files” in this Help Guide.

**Note**

- The HDD AUDIO PLAYER is equipped with a built-in antenna for wireless LAN. Make sure to keep a distance between the HDD AUDIO PLAYER and speakers or other devices to maintain good wireless communication.

**Hint**

- We recommend using a wired LAN when you transfer a large number of music files from your computer to the HDD AUDIO PLAYER, such as when you transfer music files for the first time, to save transfer time.
- It may take a while before the file registration is completed, as transferring, analyzing and registering music files takes time when a large number of music files are transferred to the HDD AUDIO PLAYER.

---

[12] Preparations

## Prep 1. Connecting an amplifier

---

First, you need to connect an amplifier to the HDD AUDIO PLAYER.

**Note**

- Make sure that the AC power cord (mains lead) of the HDD AUDIO PLAYER is unplugged when connecting any other cord.

## Connecting to the LINE OUT UNBALANCED jacks using an audio cord

Connect an amplifier to the LINE OUT UNBALANCED jacks on the rear panel of the HDD AUDIO PLAYER using an audio cord (supplied) as shown in the illustration below.

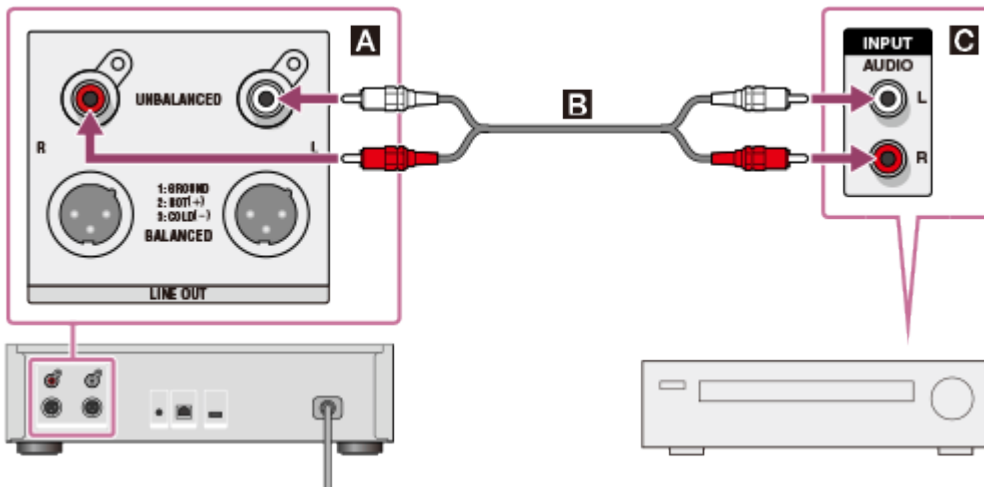

- A:** LINE OUT UNBALANCED L/R jacks of the HDD AUDIO PLAYER
- B:** Audio cord (supplied)
- C:** Analog input jack of an amplifier

## Connecting to the LINE OUT BALANCED jacks using XLR balanced cords

Connect an amplifier to the LINE OUT BALANCED jacks on the rear panel of the HDD AUDIO PLAYER using XLR balanced cords (not supplied).

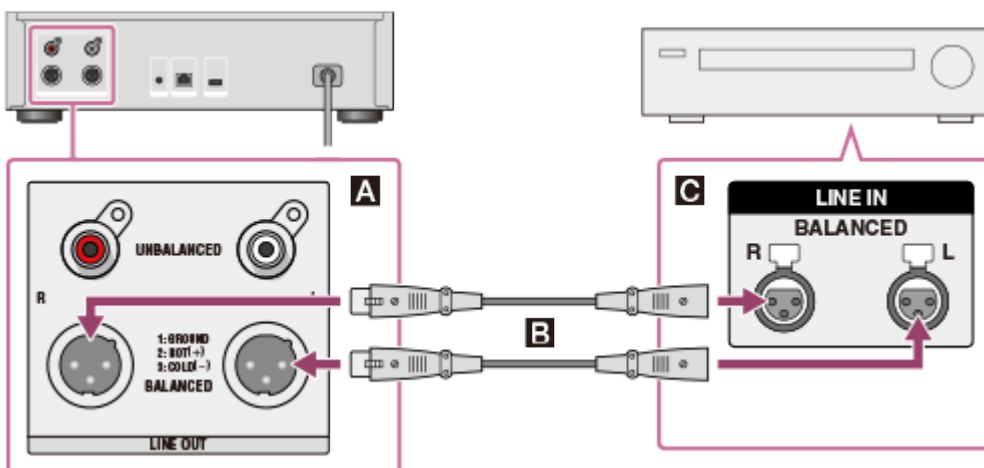

- A:** LINE OUT UNBALANCED L/R jacks of the HDD AUDIO PLAYER
- B:** XLR balanced cords (not supplied)
- C:** Analog input jack of an amplifier

## Operating a connected amplifier

You can operate a connected amplifier using the remote control supplied with the HDD AUDIO PLAYER or the dedicated application if you connect the supplied monaural mini-plug

cable or IR blaster.

## When you use a Sony amplifier equipped with an IR input jack.

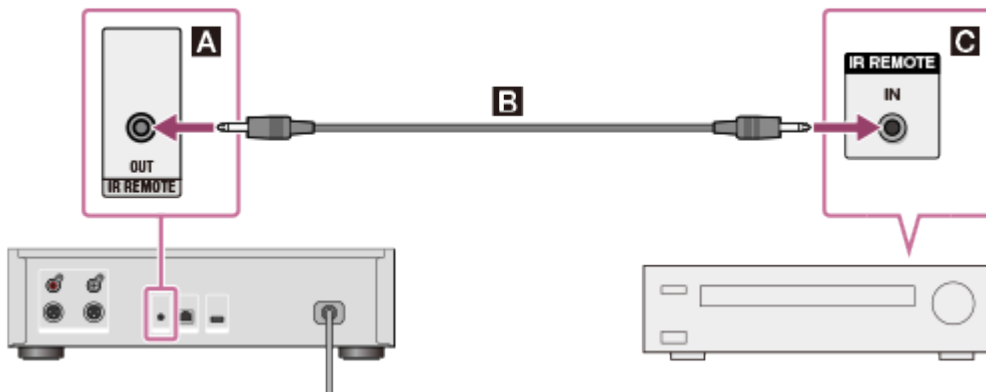

**A:** IR REMOTE OUT jack of the HDD AUDIO PLAYER

**B:** Monaural mini-plug cable (supplied)

**C:** IR input jack of an amplifier

For details on how to operate an amplifier, see [“Operating a Sony amplifier using the remote control or dedicated application.”](#)

## When you use a Sony amplifier not equipped with an IR input jack or an amplifier from other manufacturers.

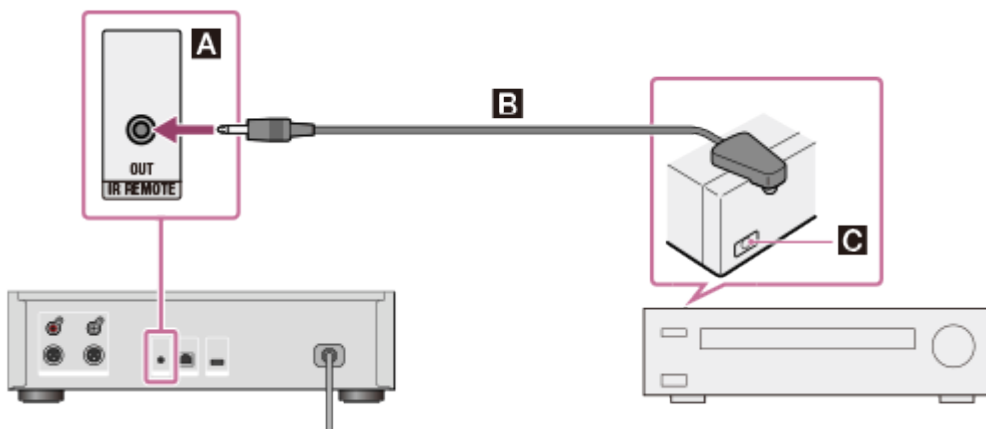

**A:** IR REMOTE OUT jack of the HDD AUDIO PLAYER

**B:** IR blaster (supplied)

**C:** The remote sensor (receiver) of a connected amplifier

For details on how to operate an amplifier, see [“Operating an amplifier manufactured by another company using the supplied remote control or a dedicated application.”](#)

### Note

- The XLR balanced cords are locked in place. Forcibly removing them may damage the connected devices. Make sure to unlock and disconnect the XLR balanced cord before moving the HDD AUDIO PLAYER.
- The HDD AUDIO PLAYER is equipped with a built-in antenna for wireless LAN. Make sure to keep a distance between the HDD AUDIO PLAYER and speakers or other devices to maintain good wireless communication.



## Hint

- When you connect an amplifier to the HDD AUDIO PLAYER using the XLR balanced cords, the output is less affected by surrounding noise sources.

---

### [13] Preparations

## Prep 2. Connecting to a network with a LAN cable (only when using a wired LAN)

---

You need to connect the HDD AUDIO PLAYER to the same network as your computer. We recommend using a wired LAN connection when you transfer music files stored on your computer to the HDD AUDIO PLAYER for the first time.

Connect the LAN cable (only one cable is supplied) between the LAN (10/100/1000) port on the rear panel of the HDD AUDIO PLAYER and a router.

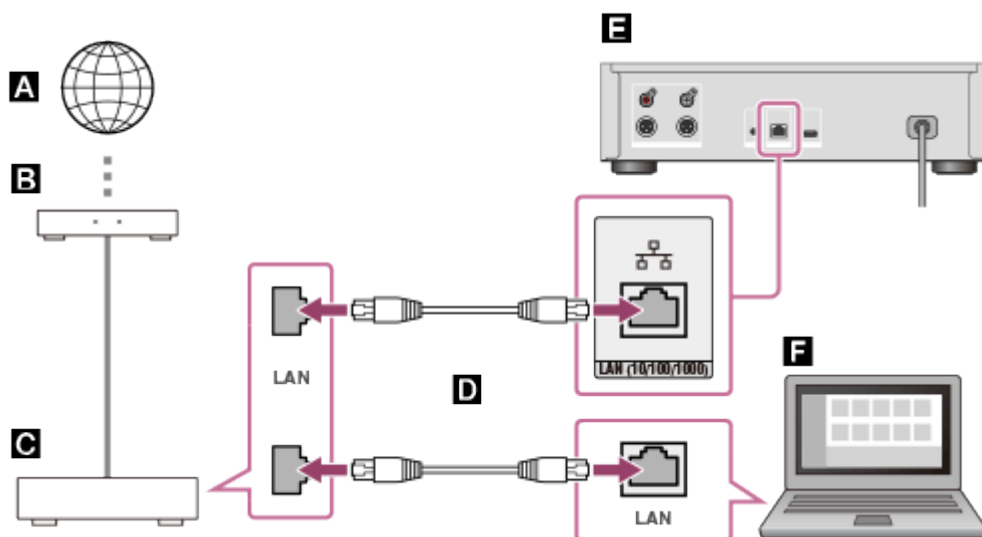

- A**: Internet
- B**: Modem
- C**: Router
- D**: LAN cables (only one cable is supplied)
- E**: LAN (10/100/1000) port of the HDD AUDIO PLAYER
- F**: Computer

---

### [14] Preparations

## Prep 3. Turning on the HDD AUDIO PLAYER

---

When you have made all connections with the other devices, connect the supplied AC power cord (mains lead), then turn on the HDD AUDIO PLAYER.

1. Firmly connect the supplied AC power cord (mains lead) to the AC IN jack on the rear panel of the HDD AUDIO PLAYER, then connect the plug to a wall outlet (mains).

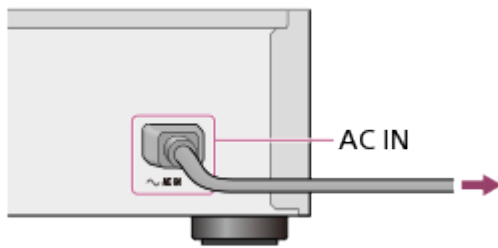

2. Press  to turn on the HDD AUDIO PLAYER.



The power lamp lights up in green.

---

[15] Preparations

## Prep 4. Configuring the initial settings of the HDD AUDIO PLAYER

---

When you turn on the HDD AUDIO PLAYER for the first time, it automatically enters the initial settings mode. You can configure the initial settings of the HDD AUDIO PLAYER easily by following the instructions on the screen.

Refer to each related topic for details on each item of the initial settings.

1. Press  to turn on the HDD AUDIO PLAYER.
2. Configure the initial settings by following the instructions on the screen.  
When a screen appears to indicate that the initial settings are completed, select [Close].

---

[16] Preparations

## Prep 5. Configuring the settings of a computer to use HAP Music Transfer

---

You can transfer music files managed on your computer to the HDD AUDIO PLAYER using HAP Music Transfer. The music files are saved in the hard disk drive of the HDD AUDIO PLAYER, so you can enjoy playing tracks without worrying about the status of the network connection, even if those tracks are large files with a high sound quality.

For details on the operations of HAP Music Transfer, refer to the HAP Music Transfer Help.

1. Download the HAP Music Transfer application from the following website:

**Models for the USA and Canada:**

<http://esupport.sony.com/swu/8811>

**Models for Europe:**

[www.sony.eu/support](http://www.sony.eu/support)

2. Install HAP Music Transfer.  
Install the application by following the instructions on the screen.
3. Launch HAP Music Transfer to transfer music files to the HDD AUDIO PLAYER.

---

[17] Preparations

## Operating the HDD AUDIO PLAYER from your smartphone or tablet (using HDD Audio Remote)

---

### What you can do using HDD Audio Remote

You can operate the HDD AUDIO PLAYER using your smartphone or tablet by installing HDD Audio Remote, a dedicated application for smartphones and tablets.

HDD Audio Remote allows you to browse and play audio files stored in the HDD AUDIO PLAYER from your smartphone or tablet.

You can also add tracks to playlists, edit information such as the genre, artist, album and track title of music files, and more.

Install the application to your smartphone or tablet.

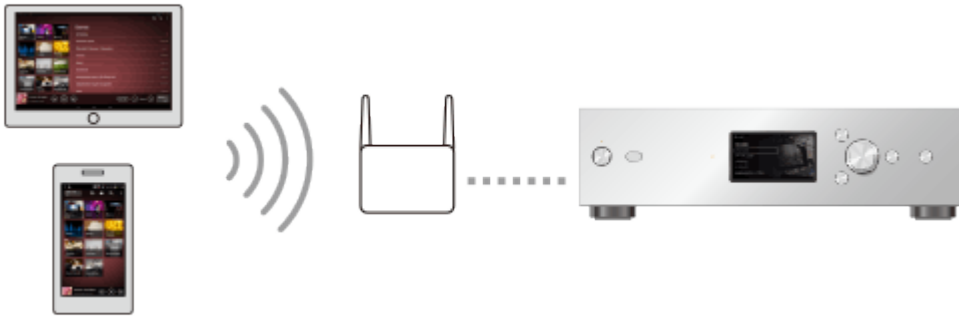

---

## Downloading HDD Audio Remote

Download HDD Audio Remote from the following websites:

- For Android devices: Google Play
- For iPhone/iPod touch/iPad: App Store

---

[18] Preparations

## Preparing the remote control

---

Open the lid of the remote control and insert two R03 (size-AAA) batteries. Place the batteries so that the + and – ends are in the correct position.

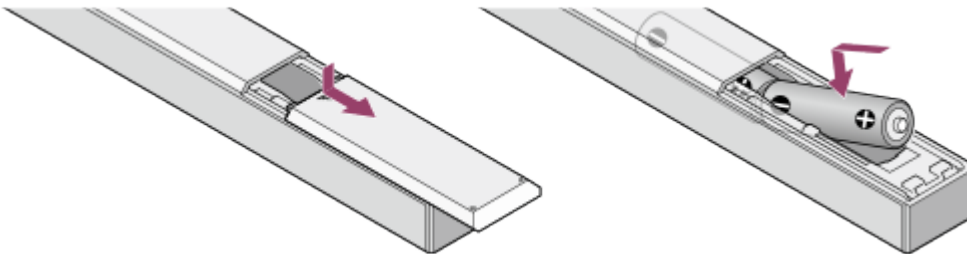

### Note

- Do not leave the remote control in an extremely hot or humid place.
- Do not use a new battery and an old one together.
- Do not mix different kinds of batteries.
- If you do not intend to use the remote control for an extended period of time, remove the batteries to avoid possible damage from battery leakage and corrosion.

---

[19] Connections

## Connecting to a computer

---

You need to connect the HDD AUDIO PLAYER to your computer through a wired LAN or Wi-Fi (wireless LAN).

**Hint**

- A wired LAN connection enables you to transfer music files more quickly.  
Using a wired LAN is especially recommended when transferring large volumes of data, such as when transferring music files stored on your computer to the HDD AUDIO PLAYER for the first time.
- The Wi-Fi (wireless LAN) function of the HDD AUDIO PLAYER turns off when you select the wired LAN setting.

## Using a wired LAN connection

Connect the LAN cable (only one cable is supplied) between the LAN (10/100/1000) port on the rear panel of the HDD AUDIO PLAYER and a router.

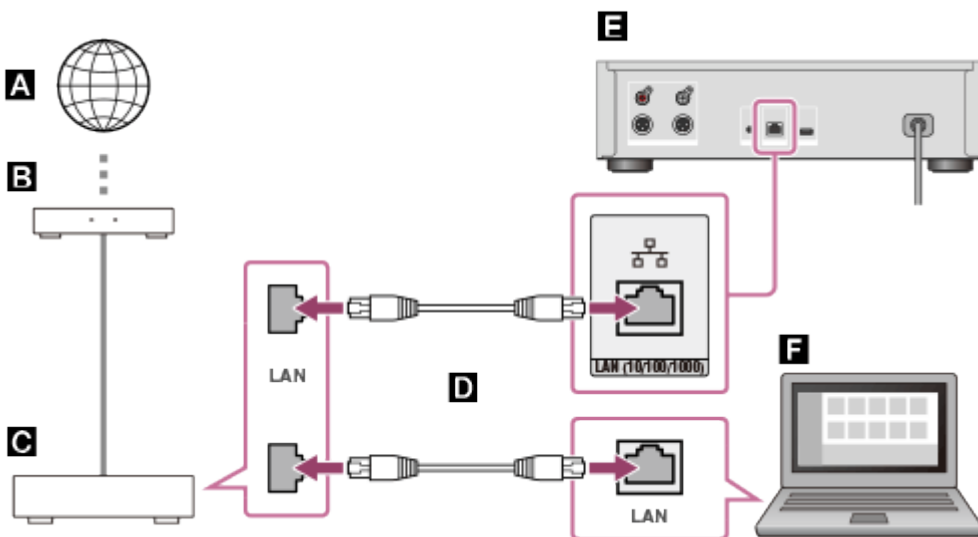

- A**: Internet
- B**: Modem
- C**: Router
- D**: LAN cables (only one cable is supplied)
- E**: LAN (10/100/1000) port of the HDD AUDIO PLAYER
- F**: Computer

## Using a Wi-Fi (wireless LAN) connection

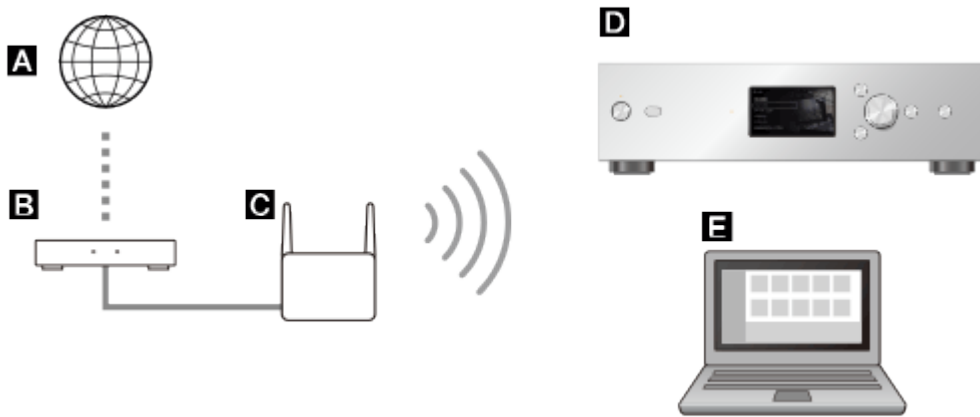

- A**: Internet
- B**: Modem
- C**: Router
- D**: HDD AUDIO PLAYER
- E**: Computer

[20] Connections

## Connecting an amplifier

You need to connect an amplifier to the HDD AUDIO PLAYER.

### Note

- Make sure that the AC power cord (mains lead) of the HDD AUDIO PLAYER is unplugged when connecting any other cord.

## Connecting to the LINE OUT UNBALANCED jacks using an audio cord

Connect an amplifier to the LINE OUT UNBALANCED jacks on the rear panel of the HDD AUDIO PLAYER using an audio cord (supplied) as shown in the illustration below.

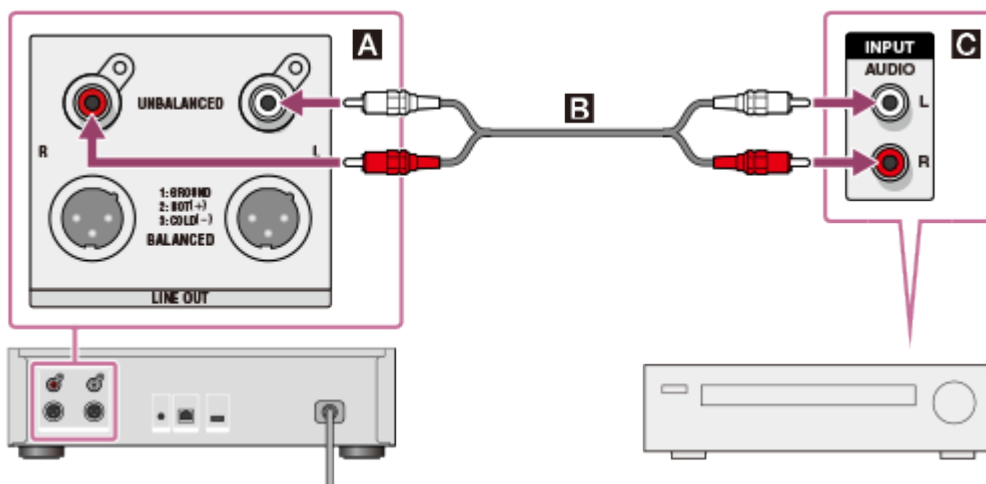

- A**: LINE OUT UNBALANCED L/R jacks of the HDD AUDIO PLAYER
- B**: Audio cord (supplied)
- C**: Analog input jack of an amplifier

## Connecting to the LINE OUT BALANCED jacks using XLR balanced cords

Connect an amplifier to the LINE OUT BALANCED jacks on the rear panel of the HDD AUDIO PLAYER using XLR balanced cords (not supplied).

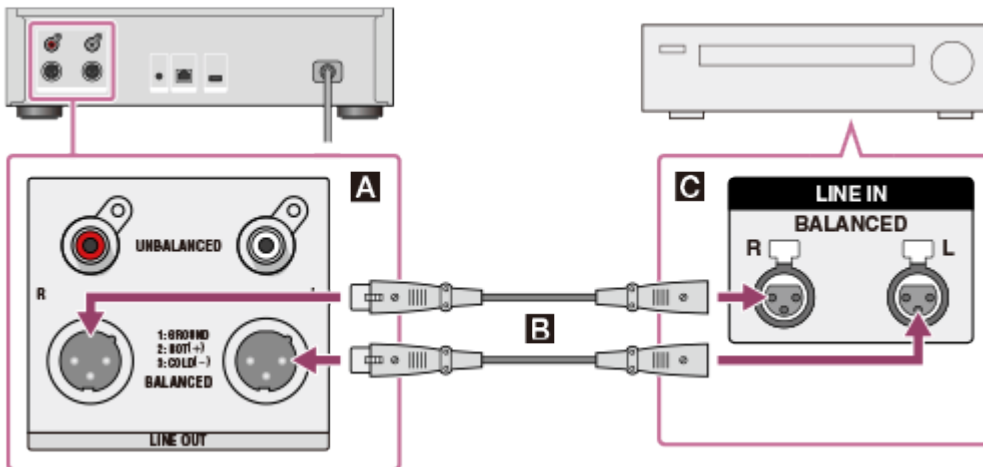

- A**: LINE OUT UNBALANCED L/R jacks of the HDD AUDIO PLAYER
- B**: XLR balanced cords (not supplied)
- C**: Analog input jack of an amplifier

## Operating a connected amplifier

You can operate a connected amplifier using the remote control supplied with the HDD AUDIO PLAYER or the dedicated application if you connect the supplied monaural mini-plug cable or IR blaster.

**When you use a Sony amplifier equipped with an IR input jack.**

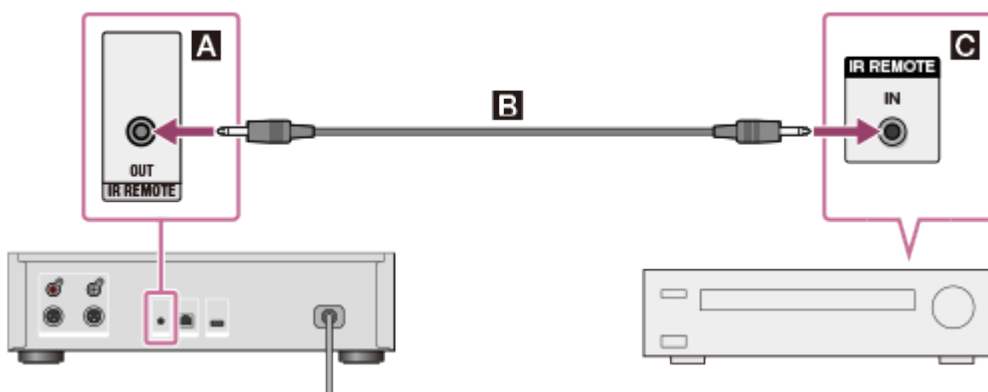

- A**: IR REMOTE OUT jack of the HDD AUDIO PLAYER
- B**: Monaural mini-plug cable (supplied)
- C**: IR input jack of an amplifier

For details on how to operate an amplifier, see [“Operating a Sony amplifier using the remote](#)

control or dedicated application.”

**When you use a Sony amplifier not equipped with an IR input jack or an amplifier from other manufacturers.**

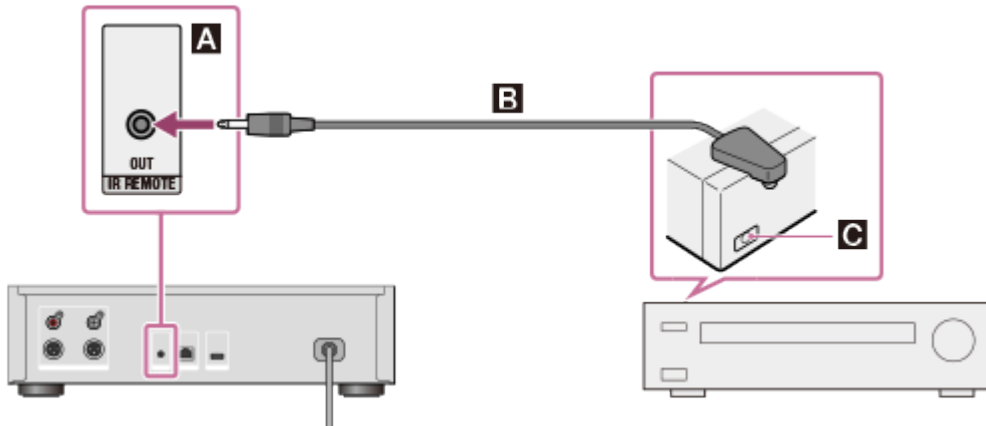

**A**: IR REMOTE OUT jack of the HDD AUDIO PLAYER

**B**: IR blaster (supplied)

**C**: The remote sensor (receiver) of a connected amplifier

For details on how to operate an amplifier, see “Operating an amplifier manufactured by another company using the supplied remote control or a dedicated application.”

#### Note

- The XLR balanced cords are locked in place. Forcibly removing them may damage the connected devices. Make sure to unlock and disconnect the XLR balanced cord before moving the HDD AUDIO PLAYER.
- The HDD AUDIO PLAYER is equipped with a built-in antenna for wireless LAN. Make sure to keep a distance between the HDD AUDIO PLAYER and speakers or other devices to maintain good wireless communication.

#### Hint

- When you connect an amplifier to the HDD AUDIO PLAYER using the XLR balanced cords, the output is less affected by surrounding noise sources.

---

[21] Connections

## Connecting an external hard disk drive

---

You can connect an external hard disk drive (USB storage) to the EXT port on the rear panel of the HDD AUDIO PLAYER. The music files transferred from your computer to the external hard disk drive can be played in the same way as music files stored in the internal hard disk drive of the HDD AUDIO PLAYER.

#### Note



- Compatible with USB 2.0.
- Be sure to connect or disconnect the external hard disk drive (USB storage) only when the HDD AUDIO PLAYER is in the standby mode.
- The HDD AUDIO PLAYER registers content stored in the external hard disk drive to the database in the HDD AUDIO PLAYER. If there is insufficient database capacity, you cannot transfer any more music file or scan the content of a newly connected external hard disk drive. In this case, delete unnecessary music files and perform the Rescan HDD function. If this does not solve the problem, perform the Factory Reset function or the Clear Database function, connect an external hard disk drive, and then rescan the external hard disk drive.
- Only the external hard disk drive that is currently connected can be used at the same time as the internal hard disk drive.
- The HDD AUDIO PLAYER is compatible with the ext4 and FAT file systems. External hard disk drives with other file systems need to be formatted by selecting the formatting function from the menu of the HDD AUDIO PLAYER. Please note that the content of the external hard disk drive is deleted when formatting.
- You cannot use an external hard disk drive (USB storage) formatted by the HDD AUDIO PLAYER with other devices such as a computer, because the external hard disk drive is formatted only for the HDD AUDIO PLAYER. To use the external hard disk drive with other devices format it using the device you want to use it with. Please note that any music files on the external hard disk drive are deleted when the hard disk drive is deleted.
- If an external hard disk drive is connected during playback, the playback stops.
- USB hubs cannot be used.

Connect an external hard disk drive to the EXT port on the rear panel of the HDD AUDIO PLAYER as shown below.

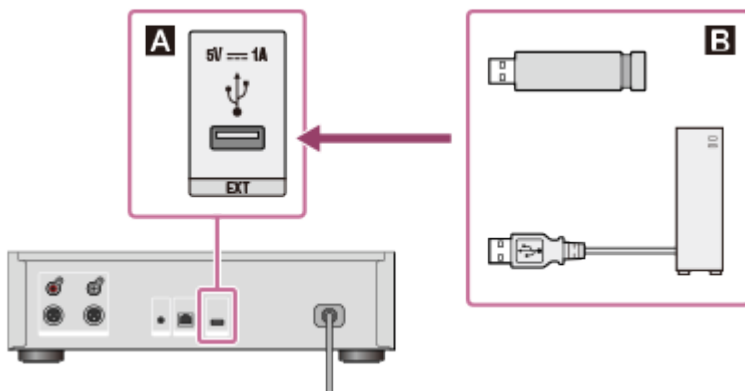

- A**: EXT port of the HDD AUDIO PLAYER  
**B**: External hard disk drive (USB storage)

---

[22] Network connections (wired LAN)

## Required network environment

---

---

You can transfer audio files from your computer to the HDD AUDIO PLAYER by connecting both to the same network, either by a wired or wireless connection.

Confirm the supported environment described below.

**Note**

- You need to connect the HDD AUDIO PLAYER to a network that can access the Internet if you want to listen to Internet radio programs.

## **Wired LAN (using a LAN cable)**

### **LAN (10/100/1000) port:**

1000BASE-T/100BASE-TX/10BASE-T

(The network speed may differ depending on the network environment.)

### **LAN cable:**

- We recommend using a LAN cable that is Cat5 or higher. A normal-type cable is also recommended, as some flat-type LAN cables are easily affected by noise.
- If the receiver is used in an environment with power supply noise from electronic devices or in a noisy network environment, use a shielded-type LAN cable.

## **Wi-Fi (using a wireless LAN network)**

### **Compatible standards:**

IEEE 802.11 b/g/n

### **Security mode:**

None

WEP

WPA/WPA2-PSK (AES)

WPA/WPA2-PSK (TKIP)

### **Radio frequency:**

2.4 GHz

**Note**

- Wi-Fi devices work on the 2.4 GHz band, which is used by a variety of devices. Wi-Fi devices use technology to minimize radio interference from other devices that use the same band. However, radio interference may still cause slower data transfer rates, reduce the communication range, or cause communication failure.
- The data transfer rate and communication range may vary depending on the following conditions:
  - Distance between devices
  - Presence of obstacles between devices
  - Device configuration
  - Signal conditions

- Surrounding environment (wall material, etc.)
- Software in use
- Communications may be cut off depending on signal conditions.
- The HDD AUDIO PLAYER does not support 5 GHz band Wi-Fi.
- The data transfer rate for IEEE 802.11g and IEEE 802.11n (2.4 GHz) devices may be affected by interference when used with IEEE 802.11b products. Also, products using IEEE 802.11g and IEEE 802.11n automatically lower the transfer rate to maintain compatibility with IEEE 802.11b products. The normal transfer rate may be regained by changing the channel settings of your access point.
- When the data transfer rate is not as fast as expected, changing the wireless channel on the access point may increase the rate.
- If a communication failure occurs while transferring music files, updating the firmware of your access point may improve the communication status.

---

[23] Network connections (wired LAN)

## Connecting the HDD AUDIO PLAYER to a network automatically

---

This topic explains how to connect the HDD AUDIO PLAYER to a wired network by obtaining an IP address automatically.

As the HDD AUDIO PLAYER can obtain an IP address automatically, you do not have to make complicated connection configurations. You can connect the HDD AUDIO PLAYER to a network simply by connecting the LAN cable (supplied).

1. Select [Settings] - [Network Settings] - [Internet Settings] from the Home screen.
2. Select [Wired Setup].  
A selection screen for the connection method appears.
3. Select [Auto].  
A network setting configuration screen appears.
4. Select [Next].  
A confirmation message for the LAN cable connection appears.
5. Select [Save & Connect].  
The HDD AUDIO PLAYER starts connecting to the network.
6. When the network connection is completed, confirm the message about the wired LAN and Internet access on the screen and then select [OK].

---

[24] Network connections (wired LAN)

## Connecting the HDD AUDIO PLAYER to a network manually

---

You can enter the IP address and other network information manually to connect the HDD AUDIO PLAYER to a wired network. Make sure that you have information such as the IP address, subnet mask, default gateway and primary/secondary DNS in advance.

1. Select [Settings] - [Network Settings] - [Internet Settings] from the Home screen.
2. Select [Wired Setup].
3. Select [Custom] on the IP address settings confirmation screen.
4. Select [Specify IP Address].  
An input screen for information such as IP address, subnet mask and default gateway appears.
5. When the IP address is surrounded by a white box, press ENTER.  
An input segment appears for the IP address.
6. Enter the IP address.  
Turn the jog dial to select a value and press ENTER to enter the selection. When you press ENTER, the input segment moves to the next number. When you press ENTER at the furthest right segment, the IP address is confirmed and the whole IP address is surrounded by the white box again.
7. If you also want to enter a subnet mask, default gateway or primary/secondary DNS, select the item you want to enter.  
Repeat the same operations as step 6.  
When the input is completed, a screen showing the network settings information appears.
8. Select [Next].  
A confirmation message for the LAN cable connection appears.
9. Select [Save & Connect].  
The HDD AUDIO PLAYER starts connecting to the network.
10. When the network connection is completed, confirm the message about the wired LAN and Internet access on the screen and then select [OK].

---

[25] Wi-Fi network connections (wireless LAN)

## Required network environment

---

You can transfer audio files from your computer to the HDD AUDIO PLAYER by connecting both to the same network, either by a wired or wireless connection.

Confirm the supported environment described below.

### Note

- You need to connect the HDD AUDIO PLAYER to a network that can access the Internet if you want to listen to Internet radio programs.

## Wired LAN (using a LAN cable)

### LAN (10/100/1000) port:

1000BASE-T/100BASE-TX/10BASE-T

(The network speed may differ depending on the network environment.)

### LAN cable:

- We recommend using a LAN cable that is Cat5 or higher. A normal-type cable is also recommended, as some flat-type LAN cables are easily affected by noise.
- If the receiver is used in an environment with power supply noise from electronic devices or in a noisy network environment, use a shielded-type LAN cable.

## Wi-Fi (using a wireless LAN network)

### Compatible standards:

IEEE 802.11 b/g/n

### Security mode:

None

WEP

WPA/WPA2-PSK (AES)

WPA/WPA2-PSK (TKIP)

### Radio frequency:

2.4 GHz

### Note

- Wi-Fi devices work on the 2.4 GHz band, which is used by a variety of devices. Wi-Fi devices use technology to minimize radio interference from other devices that use the same band. However, radio interference may still cause slower data transfer rates,

reduce the communication range, or cause communication failure.

- The data transfer rate and communication range may vary depending on the following conditions:
  - Distance between devices
  - Presence of obstacles between devices
  - Device configuration
  - Signal conditions
  - Surrounding environment (wall material, etc.)
  - Software in use
- Communications may be cut off depending on signal conditions.
- The HDD AUDIO PLAYER does not support 5 GHz band Wi-Fi.
- The data transfer rate for IEEE 802.11g and IEEE 802.11n (2.4 GHz) devices may be affected by interference when used with IEEE 802.11b products. Also, products using IEEE 802.11g and IEEE 802.11n automatically lower the transfer rate to maintain compatibility with IEEE 802.11b products. The normal transfer rate may be regained by changing the channel settings of your access point.
- When the data transfer rate is not as fast as expected, changing the wireless channel on the access point may increase the rate.
- If a communication failure occurs while transferring music files, updating the firmware of your access point may improve the communication status.

---

[26] Wi-Fi network connections (wireless LAN)

## Selecting a Wi-Fi (wireless LAN) connection method

---

You can select the most suitable network connection method for your network environment from 4 network connection methods. Confirm your network environment in advance.

### **If your wireless LAN router/access point supports the WPS (Wi-Fi Protected Setup) push button configuration method**

If your wireless LAN router/access point has a designated WPS button, you can connect to a Wi-Fi (wireless LAN) network by a single press of a button. Refer to the following link for details.

#### **Method 1. Setting up a network connection using the WPS push button configuration method**

### **If setting up a network connection by searching your access point**

You can search for available access points that are already configured and select a network name (SSID) from the search results.

Confirm the network name (SSID) and security key (WEP key or WPA key) of your wireless LAN router/access point in advance, then refer to the following link for details.

## **Method 2. Setting up a network connection by selecting an access point**

### **If connecting to a new access point**

You can add and connect a new access point by entering a network name (SSID) and security key (WEP key or WPA key) manually without using the WPS method.

Confirm the network name (SSID) and security key (WEP key or WPA key) of your wireless LAN router/access point in advance, then refer to the following link for details.

## **Method 3. Setting up a network connection by adding a new access point**

### **If your wireless LAN router/access point supports the (WPS) PIN code configuration method**

If an access point supports the (WPS) PIN (Personal Identification Number) code connection, you can set up a wireless connection by entering the (WPS) PIN code of the HDD AUDIO PLAYER into the wireless LAN router/access point.

Confirm the operations of your wireless LAN router/access point, then refer to the following link for details.

## **Method 4. Setting up a network connection using the (WPS) PIN code configuration method**

---

[27] Wi-Fi network connections (wireless LAN)

### **Method 1. Setting up a network connection using the WPS push button configuration method**

---

If your wireless LAN router/access point has a WPS button, you can easily connect the HDD AUDIO PLAYER to a Wi-Fi (wireless LAN) network.

If your wireless LAN router has an AOSS button or other easy setup button, it may support WPS. Check the operation manual of your wireless LAN router/access point for details.

1. Select [Settings] - [Network Settings] - [Internet Settings].
2. Select [Wireless Setup].
3. Select [Wi-Fi Protected Setup (WPS)].
4. Select [Start] and then press the WPS button on your wireless LAN router/access point.

The HDD AUDIO PLAYER starts searching for the access point.

5. When the connection is made, confirm the registration completion message that appears on the screen and then select [Next].
6. When the network setup is completed, select [OK] on the screen.

#### Note

- If you cannot connect to a network correctly, the following reasons are possible. Try the connection again or use another connection method.
  - You pressed the WPS button more than two minutes after selecting [Start] in step 4.
  - The WPS button may have to be pressed and held for about two minutes (depending on the router).
- You cannot cancel the connection after the HDD AUDIO PLAYER has started connecting to the network.
- Do not turn the power off while the HDD AUDIO PLAYER is connecting to the network.

#### Hint

- For details on the name and position of the WPS button on your wireless LAN router/access point, refer to the operating manual of the router/access point.

---

[28] Wi-Fi network connections (wireless LAN)

## Method 2. Setting up a network connection by selecting an access point

---

You can set up a Wi-Fi (wireless LAN) network connection by searching for an access point.

#### Note

- This connection method requires information such as the network name (SSID) (\*1) of the wireless LAN router/access point and the security key (password) (\*2) for the network.

\*1 SSID (Service Set Identifier) is a name that identifies a particular access point.

\*2 This information should be available from a label on your wireless LAN router/access point, from the operating manual, from the person who set up your wireless network, or from the information provided by your Internet service provider.

1. Select [Settings] - [Network Settings] - [Internet Settings].
2. Select [Wireless Setup].
3. Select [Select access point].

The HDD AUDIO PLAYER starts searching for available access points.



4. When the list of available network names (SSID) is displayed, select the access point you want to connect to.  
An input space for a security key (WEP/WPA) appears on the screen.  
If you have selected an access point with no security key, proceed to step 8.
5. When the input space for the security key (WEP/WPA) is surrounded by a white box, press ENTER.  
An editing display and keyboard appear.
6. Enter the security key (WEP/WPA).  
For details on how to use the keyboard, see [“How to input characters.”](#)
7. When you have finished entering the security key, select [Next].
8. When the setup is completed, select [OK].

#### Note

- You can enter 5, 13 or 26 alphanumeric characters and/or symbols for a WEP key or 8 to 63 alphanumeric characters and/or symbols for a WPA key.

#### Hint

- If you cannot find the network name (SSID) you want to connect to in step 4, add a new access point.

---

[29] Wi-Fi network connections (wireless LAN)

## Method 3. Setting up a network connection by adding a new access point

---

You can set up a wireless LAN network connection by adding a new access point.

If you cannot find the desired network name (SSID) in the list of available networks, try this connection method.

#### Note

- This connection method requires information such as the network name (SSID) (\*1) of the wireless LAN router/access point and the security key (password) (\*2) for the network.

\*1 SSID (Service Set Identifier) is a name that identifies a particular access point.

\*2 This information should be available from a label on your wireless LAN router/access point, from the operating manual, from the person who set up your wireless network, or from the information provided by your Internet service provider.

1. Select [Settings] - [Network Settings] - [Internet Settings].
2. Select [Wireless Setup].
3. Select [Select access point].  
The HDD AUDIO PLAYER starts searching for available access points.
4. When the list of available network names (SSID) is displayed, select [Add a new access point].
5. Select [Manual registration].  
An input space for the network name (SSID) appears on the screen.
6. When the input space for the network name (SSID) is surrounded by a white box, press ENTER.  
An editing display and keyboard appear.
7. Enter the network name (SSID).  
For details on how to use the keyboard, see "[How to input characters.](#)"
8. When the network name (SSID) is entered, select [Next].
9. Select the security mode of your wireless LAN router/access point from [None], [WEP], [WPA/WPA2-PSK] or [WPA2-PSK] on the security mode selection screen.
10. If you want to set up a security key, enter the security key (WEP/WPA) and then select [Next].  
Perform the same operations as step 7 to enter the security key (WEP/WPA).
11. Select either [Auto] or [Custom] on the selection screen for the IP address setup method.
12. Follow the instructions that appear in the display to set up the connection.

**Note**

- You can enter a maximum of 32 alphanumeric characters and/or symbols for a network name (SSID).
- If the security mode of your wireless LAN router/access point is not included in the options in step 9, change the security configuration of the router.
- You can enter 5, 13 or 26 alphanumeric characters and/or symbols for a WEP key or 8 to 63 alphanumeric characters and/or symbols for a WPA key.

# Method 4. Setting up a network connection using the (WPS) PIN code configuration method

---

You can set up a connection by entering the (WPS) PIN (Personal Identification Number) code of the HDD AUDIO PLAYER into the wireless LAN router/access point to authenticate the connection between the devices.

1. Select [Settings] - [Network Settings] - [Internet Settings].
2. Select [Wireless Setup].
3. Select [Select access point].  
The HDD AUDIO PLAYER starts searching for the available access point.
4. When the list of available network names (SSID) is displayed, select [Add a new access point].
5. Select [(WPS) PIN Method].  
The (WPS) PIN code for the HDD AUDIO PLAYER appears.
6. Enter the (WPS) PIN code of HDD AUDIO PLAYER into the wireless LAN router/access point.  
For details on entering the (WPS) PIN code, refer to the operating manual of your wireless LAN router/access point.
7. When you have finished entering the (WPS) PIN code, select [Start] on the HDD AUDIO PLAYER.  
The HDD AUDIO PLAYER and wireless LAN router/access point start authenticating the connection with each other.  
When the certification is completed, a confirmation screen of the network name (SSID) and security key (WEP/WPA) appears.
8. Select [Next] on the confirmation screen.
9. When the setup is completed, select [OK] on the screen.

## Note

- You cannot cancel the connection after the HDD AUDIO PLAYER has started connecting to the network.
  - Do not turn the power off while the HDD AUDIO PLAYER is connecting to the network.
-

[31] Playing music

## Playable audio file formats

---

The following audio file formats can be played on the HDD AUDIO PLAYER.

### **DSD (DSF, DSDIFF)**

Extensions: .dsf, .diff

Sampling frequency: 2.8224 MHz, 5.6448 MHz

### **LPCM (WAV, AIFF)**

Extensions: .wav, .aif, .aiff

Sampling frequency: 44.1 kHz, 48 kHz, 88.2 kHz, 96 kHz, 176.4 kHz, 192 kHz

Quantization bits: 16 bits, 24 bits, 32 bits (\*)

\* 32-bit playback is only possible for files in WAV format.

### **FLAC**

Extensions: .flac, .fla

Sampling frequency: 44.1 kHz, 48 kHz, 88.2 kHz, 96 kHz, 176.4 kHz, 192 kHz

Quantization bits: 16 bits, 24 bits

### **ALAC**

Extensions: .m4a

Sampling frequency: 44.1 kHz, 48 kHz, 88.2 kHz, 96 kHz, 176.4 kHz, 192 kHz

Quantization bits: 16 bits, 24 bits

### **MP3 (MPEG-1/2 Audio Layer-3)**

Extensions: .mp3

Bit rate: 64 kbps - 320 kbps

Sampling frequency: 44.1 kHz, 48 kHz

Quantization bits: 16 bits

### **AAC (MPEG-4 AAC-LC, HE-AAC)**

Extensions: .m4a, .mp4, .3gp

Bit rate: 64 kbps - 320 kbps

Sampling frequency: 44.1 kHz, 48 kHz

Quantization bits: 16 bits

### **WMA (WMA, WMAPro, WMA Lossless)**

Extensions: .wma, .asf

Bit rate: 32 kbps - 320 kbps (WMA, WMAPro)

Sampling frequency: 44.1 kHz, 48 kHz (WMA)

Sampling frequency: 44.1 kHz, 48 kHz, 88.2 kHz, 96 kHz (WMAPro, WMA Lossless)

Quantization bits: 16 bits (WMA, WMAPro)

Quantization bits: 16 bits, 24 bits (WMA Lossless)

### **ATRAC (ATRAC3, ATRAC3plus, ATRAC Advanced Lossless)**

Extensions: .oma, .aa3

Bit rate: 48 kbps - 352 kbps (ATRAC3plus)

Bit rate: 132 kbps (ATRAC3)

Sampling frequency: 44.1 kHz

Quantization bits: 16 bits

#### **Note**

- No copy protected files in any of the above formats can be played. If you transfer copy protected files to the HDD AUDIO PLAYER, music information of the copy protected files will appear in gray and you will not be able to select it.
- Only 2ch files in the above formats are supported.
- Playing formats other than those above may produce noise or even damage the speakers if played at a high volume.

---

[32] Playing music

## **Transferring music files from a computer to the HDD AUDIO PLAYER**

---

To play music files on the HDD AUDIO PLAYER, you first need to transfer music files from your computer to the HDD AUDIO PLAYER.

Install the HAP Music Transfer application on your computer and then transfer music files using the application.

### **Download site of HAP Music Transfer:**

Install HAP Music Transfer on your computer.

#### **Models for the USA and Canada:**

<http://esupport.sony.com/swu/8811>

#### **Models for Europe:**

[www.sony.eu/support](http://www.sony.eu/support)

For details on operations of HAP Music Transfer, refer to the HAP Music Transfer Help.

#### **Note**

- Do not transfer music files from two or more HAP Music Transfer applications (computers) at the same time.
- You can also transfer music files from your smartphone or tablet using the HDD Audio

Remote application. However, do not transfer music files from your smartphone or tablet and HAP Music Transfer at the same time.

- Do not transfer music files from two or more smartphones or tablets at the same time.

#### Hint

- A wired LAN connection enables you to transfer music files more quickly. Using a wired LAN is especially recommended when transferring large volumes of data, such as when transferring music files stored on your computer to the HDD AUDIO PLAYER for the first time.
- You can transfer music files to the HDD AUDIO PLAYER by dragging and dropping. For details, refer to [“You want to transfer music files to the HDD AUDIO PLAYER by dragging and dropping but do not know how. \(for Windows\)”](#) or [“You want to transfer music files to the HDD AUDIO PLAYER by dragging and dropping but do not know how. \(for Mac\).”](#)

---

[33] Playing music

## Playing music files

---

You need to transfer music files stored in your computer to the hard disk drive of the HDD AUDIO PLAYER before you can listen to them on the HDD AUDIO PLAYER. For details, see [“Transferring music files from a computer to the HDD AUDIO PLAYER.”](#)

#### Hint

- When using an external hard disk drive, connect the external hard disk drive to the EXT port on the rear panel of the HDD AUDIO PLAYER before you turn on the HDD AUDIO PLAYER.
1. Select a desired category from [Genres], [Artists], [Albums], [Tracks], [Folders] in the Home screen.
  2. Start playing.
    - When selecting [Genres], [Artists], [Albums], or [Tracks]:  
Select the desired item from the list and repeat this operation until you select a track. When you select a track, playback starts.  
If you want to play all tracks in a list, select [All Genres], [All Artists], or [All Albums] and then keep selecting items until you reach the desired list.
    - When selecting [Folders]:  
Select [HAP\_Internal] (to select the internal hard disk drive) or [HAP\_External] (to select the external hard disk drive), and then select the desired folder or file from the list.  
When you select a file, playback starts.

**Note**

- Do not disconnect an external hard disk drive from the HDD AUDIO PLAYER while playing a track stored in the external hard disk drive.

**Hint**

- Each transferred music file becomes available for selection once it is registered to the HDD AUDIO PLAYER.
  - The HDD AUDIO PLAYER may have sample files by default.
  - Press the ►|| button to stop playback.
  - If you turn the jog dial for two clicks or more, the Play Queue screen appears.
  - If you press the ENTER button while playing, the Playback Options screen appears.
- 

[34] Playing music

## Deleting music files from the HDD AUDIO PLAYER (when operating on the HDD AUDIO PLAYER)

---

You can delete music files from the HDD AUDIO PLAYER by device operations.

1. Display the Options screen from the list screen or Playback screen.
  - **From the list screen:**  
Press and hold ENTER while selecting a track, album, or folder you want to delete. However, you cannot display the Options screen if you have selected [All Albums].
  - **From the Playback screen:**  
Press ENTER while playing a track you want to delete.
2. Select [Delete].
3. Select [Yes].  
The selected track, album, or folder will be deleted.

**Note**

- You can delete pre-installed sample files, but they will be restored if you perform the Factory Reset function.
  - Do not turn the HDD AUDIO PLAYER off during deleting.
  - Do not disconnect the external hard disk drive during deleting.
-

## Deleting music files from the HDD AUDIO PLAYER (when using the HAP Music Transfer)

---

You can delete music files from the HDD AUDIO PLAYER using the HAP Music Transfer application.

1. Perform one of the following operations.

- For Windows:

Select [Explore HAP] from  (the HAP Music Transfer icon) on the task tray of your computer.

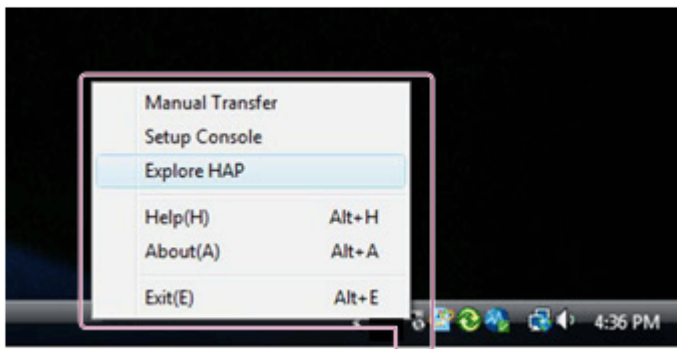

- For Mac:

Select [Explore HAP] from  (the HAP Music Transfer icon) on the Dock of your computer.



The Explorer window (for Windows) or the Finder (for Mac) opens and icon(s) of the available shared folder(s) appear. ([HAP\_Internal] appears for the internal hard disk drive and [HAP\_External] appears for the external hard disk drive if one is connected.)

2. Select [HAP\_Internal] (to select the internal hard disk drive) or [HAP\_External] (to select the external hard disk drive), and then keep selecting folders until you reach the folder that contains the music files you want to delete.
3. Delete the music files.



**Note**

- You can delete pre-installed sample files, but they will be restored if you perform the Factory Reset function.
  - Do not transfer music files using HAP Music Transfer on your computer while deleting music files in Explorer (for Windows) or in the Finder (for Mac).
  - Do not transfer music files from your smartphone or tablet while deleting music files using Explorer (for Windows) or the Finder (for Mac).
- 

[36] Playing music

## Playing tracks using SensMe™ channels

---

“SensMe™ channels” is a function that analyzes and automatically categorizes music tracks according to their mood and tempo using the 12 TONE ANALYSIS technology developed by Sony.

You can enjoy channels that suit your mood or the time of the day.

1. Select [SensMe™ channels] in the Home screen.
2. Select the desired channel.  
Playback of tracks in the channel starts.

### Details of displayed items

You can select from the following channels:

**Morning/Daytime/Evening/Night/Midnight:**

Play music for various times of the day.

**Energetic:**

Plays uptempo and high-energy music.

**Relax:**

Plays calm and relaxing music.

**Upbeat:**

Plays cheerful and uplifting music.

**Mellow:**

Plays soft and slow-tempo music.

**Lounge:**

Plays jazz and easy listening music.

**Emotional:**

Plays ballads.

**Dance:**

Plays rhythm, rap and R & B music.

**Extreme:**

Plays loud and powerful music.

**Note**

- The HDD AUDIO PLAYER must be connected to the Internet to categorize music files using SensMe™ channels, as SensMe™ channels analyzes music files and accesses the Gracenote server to obtain music information.
- All channels are displayed even if no tracks are stored in some channels.
- Some tracks may be categorized into a channel that differs from the feel of the track.
- Shuffle mode is set to [Tracks] and repeat mode is set to [All tracks] automatically and you cannot change them while playing a channel. These play modes are only active while the HDD AUDIO PLAYER is playing SensMe™ channels.
- Tracks will be removed from SensMe™ channels in the following cases:
  - The track has been deleted from the hard disk drive of the HDD AUDIO PLAYER.
  - The track is stored in an externally connected hard disk drive and this has been disconnected from the HDD AUDIO PLAYER.
  - You have performed the Factory Reset or Format HDD (for an external hard disk drive) function on the HDD AUDIO PLAYER.
- Music files that cannot be analyzed may not be categorized into SensMe™ channels automatically even if they are correctly transferred and registered in the HDD AUDIO PLAYER.
- Music files in DSD (DSF, DSIFF) audio format cannot be categorized into SensMe™ channels automatically.

**Hint**

- In the SensMe™ channels screen, press and hold the ENTER to display the Options menu. You can restore all SensMe™ channels to the default by selecting [Edit SensMe™ channels] from the Options menu.
- You can check the music files that are not registered to SensMe™ channels in [Unregistered Tracks].

---

[37] Playing music

## Playing tracks in playlists

---

The HDD AUDIO PLAYER automatically creates playlists such as a list of newly transferred tracks and a list of frequently played tracks. You can also play playlists you have created

using HDD Audio Remote.

1. Select [Playlists] in the Home screen.
2. Select the desired playlist.
3. Select a track.  
Playback starts.

## Details of displayed items

The following playlists are created automatically:

### Newly added :

Tracks that are newly added to the HDD AUDIO PLAYER. Up to 100 tracks are displayed in reverse chronological order.

### Most played :

The tracks that are most frequently played. Up to 100 tracks are displayed in descending order of frequency.

### Least played :

Tracks that are least frequently played or have never been played. Up to 100 tracks are displayed in ascending order of frequency.

### Note

- You can create up to 100 playlists. You can create your own playlists using HDD Audio Remote.
- A playlist can contain up to 1,000 tracks.
- Tracks will be removed from playlists in the following cases:
  - The track has been set as .
  - The track has been deleted from the hard disk drive of the HDD AUDIO PLAYER.
  - The track is stored in an externally connected hard disk drive and this has been disconnected from the HDD AUDIO PLAYER.
- If you perform one of the following functions on the HDD AUDIO PLAYER, all playlists you have created will be deleted. The three playlists that are automatically created will remain, but the content in these three playlists will be deleted.
  - Factory Reset
  - Format HDD (for an external hard disk drive)
  - Clear Database

### Hint

- A track is only counted as played when it is played to the end.
- If you install the HDD Audio Remote application on your smartphone or tablet, you can create playlists of tracks you like using the application.

## Selecting playback methods

---

You can operate and configure various playback settings, such as shuffle play and repeat play, using the Playback Options menu.

1. While playing a track, press ENTER.  
The Playback Options menu appears.
2. Turn the jog dial to select the item you want to set.

### Details of menu items

The following menu items can be set from the Playback Options menu.



#### Shuffle:

You can play tracks in random order (shuffle play). You can select a setting from [Off], [Tracks], [Albums], [Folders] (only when you start playing by selecting [Folders] from the Home screen). If you select [Albums] or [Folders], the order in which albums or folders are played will be shuffled, but individual tracks in each album or folder will be played in their original order.

#### Repeat:

You can play tracks repeatedly (repeat play). You can select a setting from [Off], [1 Track], [All tracks].

#### Favorite:

You can add  to tracks you like. You can also remove  or add  to track.

#### DSEE:

You can set the DSEE function to [Auto] or [Off].

#### Get music info:

The HDD AUDIO PLAYER accesses the Gracenote server to obtain music information on the track currently playing.

Select the desired option from the music information, and then select [Use]. The music information will be registered to the track currently playing.

#### Edit SensMe™ channels:

You can edit the SensMe™ channels of the currently playing track or restore them to the default.

#### Delete:

You can delete the track currently playing.

If you delete a track, playback will be stopped.

## Sleep:

You can set the Sleep timer. When the specific time you set has elapsed, the HDD AUDIO PLAYER is automatically turned off.

### Note

- Shuffle mode is set to [Tracks] and repeat mode is set to [All tracks] automatically and you cannot change them while playing a channel. These play modes are only active while the HDD AUDIO PLAYER is playing SensMe™ channels.

---

[39] Playing music

## Registered music file information

---

The HDD AUDIO PLAYER analyzes the ID3 tag information, a type of music information metadata contained in music files, and registers the files to [Genres], [Artists], [Albums] and [Tracks]. If music files do not contain ID3 tags or if any of the information is missing, the HDD AUDIO PLAYER automatically accesses the Gracenote server on the Web and obtains music information.

You can also obtain music information by displaying the Options screen from the list screen or Playback screen and then selecting [Get music info].

## Music file management on the HDD AUDIO PLAYER

The HDD AUDIO PLAYER registers music information obtained from music files when you transfer them to the HDD AUDIO PLAYER.

The HDD AUDIO PLAYER utilizes music information about the album name, album artist name, album art image, track name, track artist name, track number and track genre from each music file.

The method of embedding music information differs depending on the music file management software or tag editing software.

Music information is classified on the list screen of the HDD AUDIO PLAYER as follows.

**Genres:** Displays the track genre in [Genres].

**Artists:** Displays the track artist name in [Artists].

**Albums:** Displays information composed of the album name and album artist name in [Albums].

**Tracks:** Displays the track name in [Tracks].

### Note

- The HDD AUDIO PLAYER must be connected to the Internet to analyze music files and access the Gracenote server to obtain music information.

WAV files generally do not contain ID3 tag information. When a music file does not contain ID3 tag information, that file is registered in [Unknown Genre], [Unknown Artist], [Unknown Album] and [Tracks] with its file name. However, if the music information can be analyzed and obtained from the Gracenote database, that file is re-registered to Genres, Artists, Albums and Tracks.

- The correct music information may not be obtained for some files due to the type of music file.
- Some music file management software only manages the music information in the database on your computer and does not embed any music information to the music files. In other cases, some music file management software embeds part of the music information to the music files.
- The method of embedding music information differs depending on the music file format in some music file management software.
- Some music file management software uses a different method from the HDD AUDIO PLAYER to construct an album from multiple tracks.

---

[40] Playing music

## Standby modes

---

The HDD AUDIO PLAYER has two types of standby mode: normal standby mode and Network Standby mode.

### Standby mode

Press the  button to switch to standby mode so that you can save power.

(The HDD AUDIO PLAYER enters this standby mode if the Network Standby mode is disabled. The HDD AUDIO PLAYER cannot be operated through the network.)

### Network Standby mode

In this mode, the network function is activated even when the HDD AUDIO PLAYER is in standby mode.

This function is useful in the following cases:

- When music files are transferred to the HDD AUDIO PLAYER using the HAP Music Transfer application.
- When you want to launch the HDD AUDIO PLAYER from the HDD Audio Remote application.

Select [Settings] - [System Settings] - [Network Standby] from the menu to set the Network Standby mode.

**Note**

- The HDD AUDIO PLAYER does not enter standby mode when music files are being transferred from your computer, smartphone or tablet or when the HDD AUDIO PLAYER is analyzing transferred music files, even if you press the  button to switch to standby mode. The HDD AUDIO PLAYER enters standby after all target music files are transferred and analyzed.

#### Hint

- The HDD AUDIO PLAYER enters the Network Standby mode after 20 minutes of no operations and no playback if [Auto Standby] is set to [On] (factory default setting).

---

[41] Internet radio

## Listening to the TuneIn Internet radio programs



---

You can connect and listen to worldwide Internet radio streaming programs using TuneIn Internet radio.

#### Note

- If [Internet Radio] is not displayed in the Home screen, update the HDD AUDIO PLAYER using the Network Update function in the Settings menu.
  1. Select [Internet Radio] - [TuneIn].
  2. Select [Select Station or Show].
  3. Select the desired item and repeat this operation according to the instructions that appear in the display until you find the desired radio station or show.  
Streaming starts.

#### Note

- Before using, please read the TuneIn End User License Agreement. You must agree to the End User License Agreement in order to use TuneIn.
- If you select [Internet Radio] in step 1, an End User License Agreement may appear on the screen. You must agree to the End User License Agreement in order to use the Internet radio function continuously.
- If you select Internet radio while playing a track in the hard disk drive, the playback stops.
- Internet content may be discontinued or changed without notice.
- You can add  to a radio station or show, but it may take some time before the list is updated. To check the list after you have added , wait for a short while, go back up several layers and then select [Favorites] again.
- Episodes are registered to favorites as the whole show.  will not be displayed on the

episode list.

- Some radio stations or shows cannot be registered to favorites, or  does not appear on the list screen.
- The displayed content length may not match the real status of the content depending on the show.
- You cannot pause the content.
- Correct playback may not be possible when listening to a custom URL set on the TuneIn website, another device, etc. via the HDD AUDIO PLAYER.

#### Hint

- If you select [Favorites] in step 2, the list of stations or shows registered as favorites appears. You can select a radio station or show from the list and start streaming immediately.
- You can listen to TuneIn without registering your device. However, you need to register the HDD AUDIO PLAYER using a web browser to access favorites set on another device. After creating an account on the TuneIn website, input the registration code on the Device Registration page. To check the TuneIn Registration Code, select [Internet Radio] - [TuneIn] - [Device Registration] from the Home screen.
- You can select the bitrate or audio codec according to the radio stations or shows. If streaming is interrupted, it may be improved by selecting the lower bitrate stream. Select [Stream] from the Options menu.

---

[42] Internet radio

## Listening to the vTuner Internet radio programs

---

You can connect and listen to worldwide Internet radio streaming programs using vTuner Internet radio.

#### Note

- If [Internet Radio] is not displayed in the Home screen, update the HDD AUDIO PLAYER using the Network Update function in the Settings menu.

1. Select [Internet Radio] - [vTuner].
2. Select [Select Station].
3. Select the desired item and repeat this operation according to the instructions that appear in the display until you select a radio station.  
Streaming starts.

#### Note



- If you select [Internet Radio] in step 1, an End User License Agreement may appear on the screen. You must agree to the End User License Agreement in order to use the Internet radio function continuously.
- You cannot select grayed out stations as these are currently unavailable.
- If you select Internet radio while playing a track in the hard disk drive, the playback stops.
- Internet content may be discontinued or changed without notice.

#### Hint

- If you select [Station History] in step 2, a list of recently streamed radio stations appears on the screen. You can select a radio station from the list and start streaming immediately.
- If you select [Favorite Stations] in step 2, a list of stations with  added appears. You can select a radio station from the list and start streaming immediately.

---

[43] Useful functions

## Deleting music files from the HDD AUDIO PLAYER (when operating on the HDD AUDIO PLAYER)

---

You can delete music files from the HDD AUDIO PLAYER by device operations.

1. Display the Options screen from the list screen or Playback screen.
  - **From the list screen:**  
Press and hold ENTER while selecting a track, album, or folder you want to delete. However, you cannot display the Options screen if you have selected [All Albums].
  - **From the Playback screen:**  
Press ENTER while playing a track you want to delete.
2. Select [Delete].
3. Select [Yes].  
The selected track, album, or folder will be deleted.

#### Note

- You can delete pre-installed sample files, but they will be restored if you perform the Factory Reset function.
- Do not turn the HDD AUDIO PLAYER off during deleting.
- Do not disconnect the external hard disk drive during deleting.

---

[44] Useful functions

## Deleting music files from the HDD AUDIO PLAYER (when using the HAP Music Transfer)

---

You can delete music files from the HDD AUDIO PLAYER using the HAP Music Transfer application.

1. Perform one of the following operations.

- For Windows:

Select [Explore HAP] from  (the HAP Music Transfer icon) on the task tray of your computer.

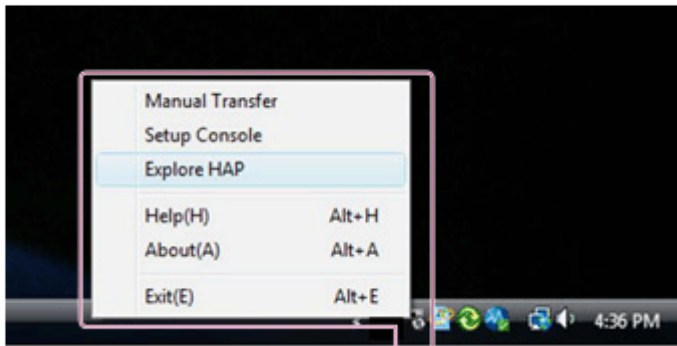

- For Mac:

Select [Explore HAP] from  (the HAP Music Transfer icon) on the Dock of your computer.



The Explorer window (for Windows) or the Finder (for Mac) opens and icon(s) of the available shared folder(s) appear. ([HAP\_Internal] appears for the internal hard disk drive and [HAP\_External] appears for the external hard disk drive if one is connected.)

2. Select [HAP\_Internal] (to select the internal hard disk drive) or [HAP\_External] (to select the external hard disk drive), and then keep selecting folders until you reach the folder that contains the music files you want to delete.
3. Delete the music files.

## Note

- You can delete pre-installed sample files, but they will be restored if you perform the Factory Reset function.
- Do not transfer music files using HAP Music Transfer on your computer while deleting music files in Explorer (for Windows) or in the Finder (for Mac).
- Do not transfer music files from your smartphone or tablet while deleting music files using Explorer (for Windows) or the Finder (for Mac).

[45] Useful functions

## Using the DSEE function

When the DSEE (Digital Sound Enhancement Engine) function is set to [Auto] (factory default setting), the HDD AUDIO PLAYER offers natural and expansive sound by restoring both high-frequency signals and fine fade-out sound that is likely to be lost by compression in compressed audio sources, or restoring fine fade-out sound that is likely to be lost by quantization in PCM audio sources with lossless compression.

The left figures are images of sound without using the DSEE function, and the right figures are images of sound using the DSEE function.

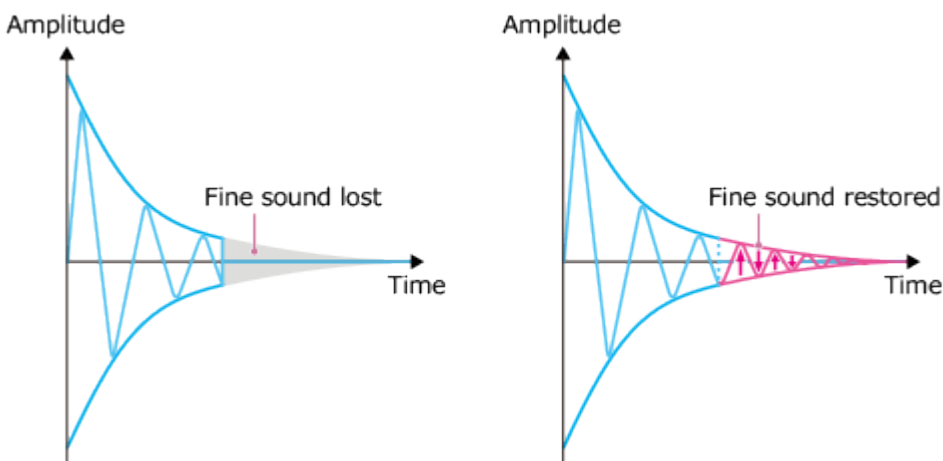
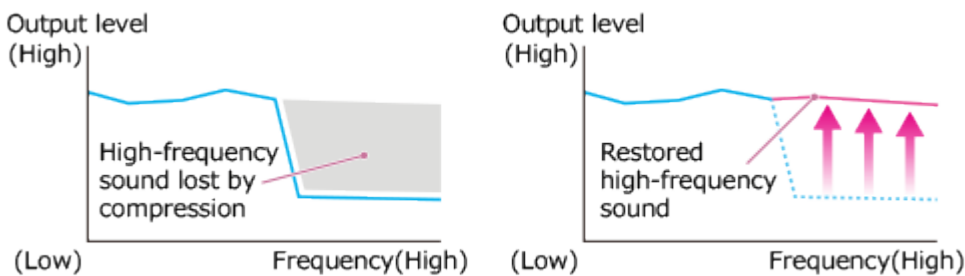

## Note

- Only the fine sound restoration feature of the DSEE function will be applied to PCM audio sources with lossless compression. The DSEE function does not work for DSD (DSDIFF, DSF) format files.

#### Hint

- DSEE stands for Digital Sound Enhancement Engine, a high range compensation and fine sound restoration technology developed independently by Sony.
  1. Select [Settings] – [Audio Settings] from the Home screen.
  2. Select [DSEE ].
  3. Select [Auto].

The DSEE function automatically works for compressed audio sources and PCM audio sources with lossless compression. The DSEE lamp lights up while the DSEE function is active.

#### Hint



- You can also set this function using the Playback Options menu during playback.

---

[46] Useful functions



## Adding tracks to “Favorites”

---

You can add  to tracks you like and  to tracks you dislike. If you add  to tracks, the tracks will be registered to “Favorites”, and you can later select one of these tracks from “Favorites” or play all of your favorite tracks together.



1. Press ENTER while playing a track you like.

The Playback Options screen appears.
2. Select [Favorite].

The setting on the right will be highlighted.
3. Select a setting from [  (none)], [  ], and [  ].

If you add [  ] to the track, it will be registered to “Favorites.”

#### Note

- If you change the setting of the track that is currently playing  , playback stops and the track will not be played in future.
- Tracks with  added will not be played, as these tracks are not entered in the Play



Queue. For example, when you listen to all tracks in an album, tracks with will not be included in the playback of that album. If you want to play a file with , select the track from the list directly.

- Tracks will be removed from “Favorites” in the following cases:
  - The track has been deleted from the hard disk drive of the HDD AUDIO PLAYER.
  - The track is stored in an externally connected hard disk drive and this has been disconnected from the HDD AUDIO PLAYER.
  - You have performed the Clear Database function.
  - You have performed the Factory Reset or Format HDD (for an external hard disk drive) function on the HDD AUDIO PLAYER.

#### Hint

- You can also add to radio stations and shows you like while playing TuneIn Internet radio programs. The radio stations and shows with added will not be displayed in the “Favorites” list, but you can select them from the Home screen - [Internet Radio] - [TuneIn] - [Favorites].
- You can also add to radio stations you like while playing vTuner Internet radio programs. The radio stations with added will not be displayed in the “Favorites” list, but you can select them from the Home screen - [Internet Radio] - [vTuner] - [Favorite Stations].

---

[47] Useful functions

## Playing tracks in “Favorites”

---

If you add to tracks, the tracks will be registered to “Favorites” and you can later select one of these tracks from “Favorites” or play all of your favorite tracks together.

1. Select [Favorites] in the Home screen.
2. Select a track you want to play.  
Playback starts.

#### Note

- If you change the setting of a track in “Favorites” to (none) or , the track will be removed from “Favorites.”
- If you change the setting of the track that is currently playing , playback stops and the track will not be played in future.
- Tracks will be removed from “Favorites” in the following cases:
  - The track has been deleted from the hard disk drive of the HDD AUDIO PLAYER.

- The track is stored in an externally connected hard disk drive and this has been disconnected from the HDD AUDIO PLAYER.
- You have performed the Clear Database function.
- You have performed the Factory Reset or Format HDD (for an external hard disk drive) function on the HDD AUDIO PLAYER.

---

[48] Useful functions

## Operating an external amplifier using the remote control or the dedicated application

---



If you register the remote control of a connected amplifier to the HDD AUDIO PLAYER, you can operate the connected amplifier using the remote control of the HDD AUDIO PLAYER or the dedicated HDD Audio Remote application.

The HDD AUDIO PLAYER is set to operate Sony amplifiers by default. You can set the HDD AUDIO PLAYER to operate amplifiers from other manufacturers by changing the settings. Use the [Settings] - [Amp Control Settings] menu to configure the settings for the amplifier you are using.

### Operations you can perform

#### Turning the power on or off



The following operations turns the power of the amplifier on or off along with the power of the HDD AUDIO PLAYER.

- On the HDD AUDIO PLAYER: Press the  button.
- On the remote control: Press the  button.
- On HDD Audio Remote: Operate the Power Control screen.

#### Adjusting the volume

- On the remote control: Press the VOLUME +/- buttons.
- On HDD Audio Remote: Tap the  /  buttons on the volume adjustment area.

#### Muting the sound

- On the remote control: Press the MUTING button.
- On HDD Audio Remote: Tap the muting button ( , , etc.)

#### Hint

- You can also configure settings so that they are not controlled by the remote control, such as when you want to turn the power of the HDD AUDIO PLAYER off but do not want to turn the amplifier off.
- If you hold down the VOLUME + button for a long time, the HDD AUDIO PLAYER may stop increasing the volume to prevent the volume level from suddenly becoming too high.

If you want to increase the volume level further, stop pressing the VOLUME + button briefly and then press it again.

- If you operate the connected amplifier using the remote control supplied with the HDD AUDIO PLAYER, operation of the amplifier may become inconsistent (operating at times but not operating at other times) due to interference of the remote control signal, especially if you continuously control the volume.

For example, if the infrared signal from the supplied remote control directly enters the remote sensor (receiver) of the connected amplifier, interference may occur with the signal input from the IR input jack of the amplifier or the signal output from the installed IR blaster. This causes the amplifier to fail to receive the correct signal, resulting in inconsistent response from the amplifier.

In this case, place the amplifier in a location where it will not be affected by the infrared signal of the remote control of the HDD AUDIO PLAYER.

It is recommended that you use HDD Audio Remote, to avoid interference problems.

---

[49] Useful functions

## Registered music file information

---

The HDD AUDIO PLAYER analyzes the ID3 tag information, a type of music information metadata contained in music files, and registers the files to [Genres], [Artists], [Albums] and [Tracks]. If music files do not contain ID3 tags or if any of the information is missing, the HDD AUDIO PLAYER automatically accesses the Gracenote server on the Web and obtains music information.

You can also obtain music information by displaying the Options screen from the list screen or Playback screen and then selecting [Get music info].

### Music file management on the HDD AUDIO PLAYER

The HDD AUDIO PLAYER registers music information obtained from music files when you transfer them to the HDD AUDIO PLAYER.

The HDD AUDIO PLAYER utilizes music information about the album name, album artist name, album art image, track name, track artist name, track number and track genre from each music file.

The method of embedding music information differs depending on the music file management software or tag editing software.

Music information is classified on the list screen of the HDD AUDIO PLAYER as follows.

**Genres:** Displays the track genre in [Genres].

**Artists:** Displays the track artist name in [Artists].

**Albums:** Displays information composed of the album name and album artist name in [Albums].

**Tracks:** Displays the track name in [Tracks].

**Note**

- The HDD AUDIO PLAYER must be connected to the Internet to analyze music files and access the Gracenote server to obtain music information.
- WAV files generally do not contain ID3 tag information. When a music file does not contain ID3 tag information, that file is registered in [Unknown Genre], [Unknown Artist], [Unknown Album] and [Tracks] with its file name. However, if the music information can be analyzed and obtained from the Gracenote database, that file is re-registered to Genres, Artists, Albums and Tracks.
- The correct music information may not be obtained for some files due to the type of music file.
- Some music file management software only manages the music information in the database on your computer and does not embed any music information to the music files. In other cases, some music file management software embeds part of the music information to the music files.
- The method of embedding music information differs depending on the music file format in some music file management software.
- Some music file management software uses a different method from the HDD AUDIO PLAYER to construct an album from multiple tracks.

---

[50] Parts and controls

## Front panel

---

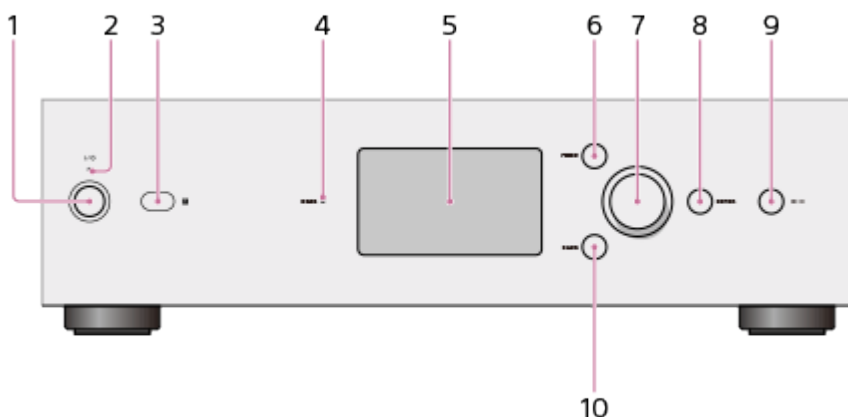

1.  $\text{I/O}$  (Power) button  
Turns the HDD AUDIO PLAYER on and off.
2. Power lamp  
When the HDD AUDIO PLAYER is turned on, this lamp lights up in green.
3. Remote sensor
4. DSEE lamp



Lights up when the DSEE function is active during playback.

5. LCD display
6. HOME button  
Displays the Home screen.
7. Jog dial  
Turn this dial to select items displayed on the screen.
8. ENTER button  
Commits a selected item.
9. ►|| (Play/Pause) button  
Starts and pauses playback.
10. BACK button  
Returns to the previous screen.

---

[51] Parts and controls

## Rear panel

---

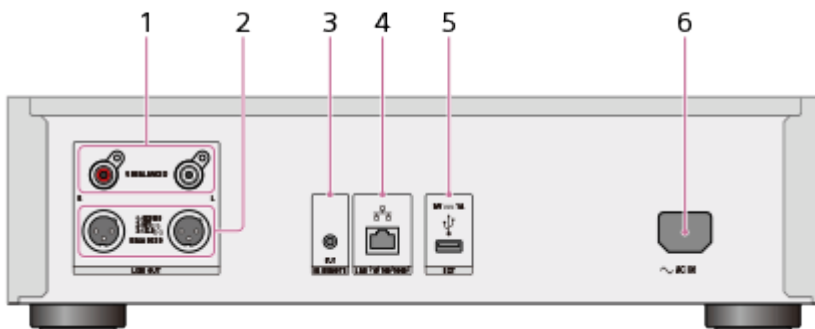

1. LINE OUT UNBALANCED (analog: unbalanced output) L/R jacks
2. LINE OUT BALANCED (analog: balanced output) L/R jacks
3. IR REMOTE OUT (infrared remote output) jack
4. LAN (10/100/1000) port
5. EXT port (  $\psi$  )
6. AC IN jack

---

[52] Parts and controls

## Remote control

---

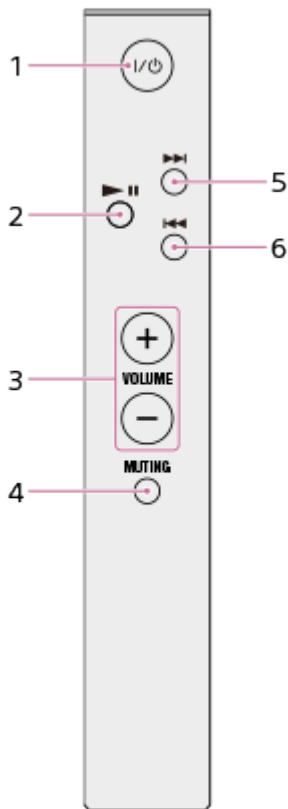

1. I/O (Power) button (\*1)  
Turns the HDD AUDIO PLAYER on and off.
2. ▶|| (Play/Pause) button  
Starts and pauses playback.
3. VOLUME +/- buttons (\*2)  
Adjusts the volume of the connected amplifier.
4. MUTING button (\*2)  
Mutes the sound of the connected amplifier. To deactivate the muting, press the MUTING button again.
5. ▶▶ (cue the beginning of the next track, fast-forward) button  
Moves to the next track. Fast-forwards when pressed and held.
6. ◀◀ (cue the beginning of the current or previous track, fast-rewind) button  
Moves to the beginning of the current or previous track. Fast-rewinds when pressed and held.

\*1 If you configure the [Amp Control Settings] so that the connected amplifier can be operated using the remote control or HDD Audio Remote, you can turn on/off the amplifier along with the HDD AUDIO PLAYER.

\*2 You can only adjust the volume or mute the sound if you have configured the [Amp Control Settings] so that the connected amplifier can be operated using the remote control or HDD Audio Remote.

#### Hint

- If you operate the connected amplifier using the remote control supplied with the HDD AUDIO PLAYER, operation of the amplifier may become inconsistent (operating at times but not operating at other times) due to interference of the remote control signal,

especially if you continuously control the volume.

For example, if the infrared signal from the supplied remote control directly enters the remote sensor (receiver) of the connected amplifier, interference may occur with the signal input from the IR input jack of the amplifier or the signal output from the installed IR blaster. This causes the amplifier to fail to receive the correct signal, resulting in inconsistent response from the amplifier.

In this case, place the amplifier in a location where it will not be affected by the infrared signal of the remote control of the HDD AUDIO PLAYER.

It is recommended that you use HDD Audio Remote, to avoid interference problems.

---

[53] Parts and controls

## Home screen

---

You can select a Home menu or check the status of the HDD AUDIO PLAYER by using the icons displayed in the Home screen.

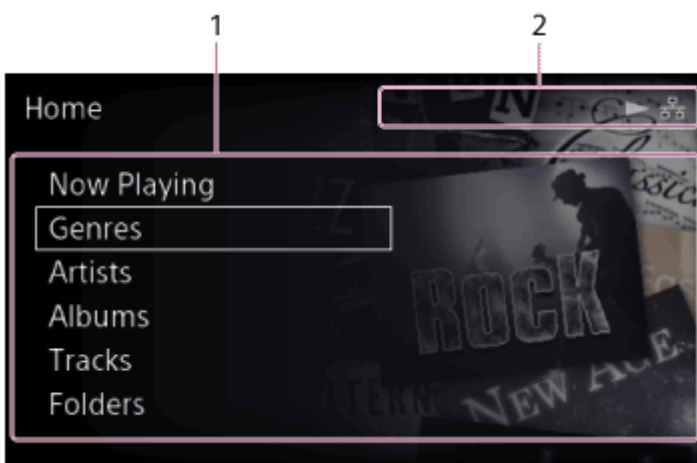

### 1. Home menu display area

Displays category menus such as Genres, Artists, Albums and Tracks, and other menu items including the Settings menu.

Selectable items are listed below:









- Now Playing
- Genres
- Artists
- Albums
- Tracks
- Folders
- SensMe™ channels
- Playlists
- Favorites

- Internet Radio
- Settings



When you select one of these items, a list screen appears, allowing you to select from the items stored in the hard disk drive or configure the various settings.

## 2. Indicators

Icons appear in this area to indicate the status of the HDD AUDIO PLAYER while the Home screen is displayed.

- Icons that indicate the network connection status:
  -  (wired LAN connection),  (wired LAN connection failed),  (wireless LAN connection),  (wireless LAN connection failed)
- Icons that indicate the playback status:
  -  (playing),  (streaming Internet radio program)
- Icons that indicate the transfer and registration status:
  -  (transferring and registering music files) (\*),  (standby for the transfer (unanalyzed audio content remains))

\* The counter shown beside this icon indicates the number of unanalyzed files.

- Icon for the sleep timer:
  -  (the sleep timer is set)
- Icon for the remote control operation:
  -  (the external amplifier is controlled by the remote control of the HDD AUDIO PLAYER or HDD Audio Remote)

## Options menus on list screens

From the Home screen, select Albums, Tracks, or Folders to display the list screen, and then press and hold ENTER while selecting an item in the list of albums, tracks, or folders to display the Options menu.

You can use the following functions from the Options menu:

### Album list screen

- [Get music info]: The HDD AUDIO PLAYER accesses the Gracenote server to obtain music information for the tracks of the album.
- [Merge albums]: The selected album can be merged with one of the albums displayed as possible albums. (Albums belonging to the same folder are displayed as possible albums.)
- [Edit SensMe™ channels]: You can restore the SensMe™ channels of the tracks of the album to the default or deregister the tracks.
- [Delete]: Delete the album currently selected.

### Track list screen

- [Get music info]: The HDD AUDIO PLAYER accesses the Gracenote server to obtain music information for the track.
- [Edit SensMe™ channels]: You can edit the SensMe™ channels of the selected track or restore them to the default.

- [Delete]: Delete the track currently selected.





## Folder list screen

- [Get music info]: The HDD AUDIO PLAYER accesses the Gracenote server to obtain music information for the files that appear in the folder list. (Music information will not be obtained for files in the sub-folders.)
- [Edit SensMe™ channels]: You can restore the SensMe™ channels of the files in the folders to the default or deregister the tracks.
- [Delete]: Delete the folder or file currently selected.

[54] Parts and controls

## Playback screen



1. Playback file information  
Displays the album art, track name, artist name, album name and file name.
2. Guide area  
Displays hints or guides for operations you can perform while playing a track.
3. Favorite status of the track  
Displays the favorite status of the current track. You can add  to tracks you like, and if the track currently playing has , this will be displayed in this area.
4. File format information  
Displays information such as the file format, sampling frequency, bit width, bit rate, etc. The information displayed varies depending on the format of the selected file.
5. Time information, playback status  
Displays the playback status (: playing, : paused, etc.), elapsed time and track length.
6. Progress bar of the playback  
Indicates the progress of the track currently playing.
7. Playback modes  
Displays the shuffle and/or repeat play setting.

## Note

- The file information of some music files may not be correctly displayed.
- If a music file does not have any file information, the HDD AUDIO PLAYER automatically accesses the Gracenote database and obtains and displays as much music file information as possible.
- When playing VBR (variable bitrate) encoded music files, the elapsed time, track length and progress bar may not match the real status of the file.
- When playing VBR (variable bitrate) encoded music files, the displayed bitrate may not always be correct.

## Hint

- If you press the ENTER button while the playback screen is displayed, the Playback Options screen appears.
- If you turn the jog dial for two clicks or more while the playback screen is displayed, the Play Queue screen appears.

---

[55] Parts and controls

## Playback Options screen

---

If you press ENTER while playing a track, the Playback Options screen appears. You can configure various playback settings, such as playback modes and sound quality settings, from the Playback Options screen.

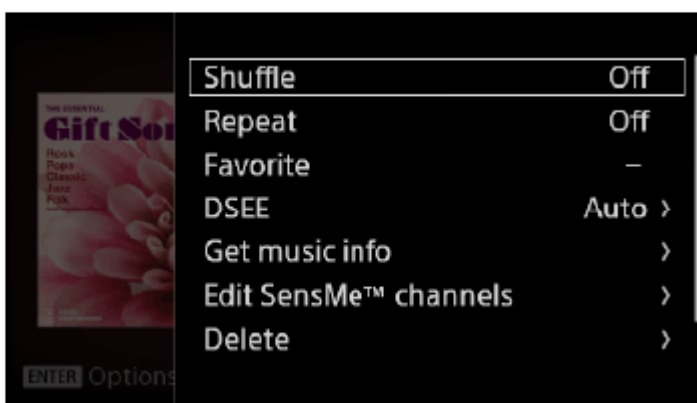



### Shuffle:

You can play tracks in random order (shuffle play). You can select a setting from [Off], [Tracks], [Albums], [Folders] (only when you start playing by selecting [Folders] from the Home screen). If you select [Albums] or [Folders], the order in which albums or folders are played will be shuffled, but individual tracks in each album or folder will be played in their original order.

**Repeat:**

You can play tracks repeatedly (repeat play). You can select a setting from [Off], [1 Track], [All tracks].

**Favorite:**

You can add  to tracks you like. You can also remove  or add  to track.

**DSEE:**

You can set the DSEE function to [Auto] or [Off].

**Get music info:**

The HDD AUDIO PLAYER accesses the Gracenote server to obtain music information on the track currently playing.

Select the desired option from the music information, and then select [Use]. The music information will be registered to the track currently playing.

**Edit SensMe™ channels:**

You can edit the SensMe™ channels of the currently playing track or restore them to the default.

**Delete:**

You can delete the track currently playing.

If you delete a track, playback will be stopped.

**Sleep:**

You can set the Sleep timer. When the specific time you set has elapsed, the HDD AUDIO PLAYER is automatically turned off.

**Note**

- Shuffle mode is set to [Tracks] and repeat mode is set to [All tracks] automatically and you cannot change them while playing a channel. These play modes are only active while the HDD AUDIO PLAYER is playing SensMe™ channels.

---

[56] Parts and controls



## Play Queue screen

---

If you turn the jog dial for two clicks or more while playing a track, the Play Queue screen appears.

The “Play Queue” is a list of all tracks currently selected to be played, such as all tracks by a certain artist or in a certain album.



The favorite status (  or  ) is displayed on the right of each track.

When you start playing by selecting [Folders] from the Home screen, the file names are displayed instead of the track names on the Play Queue screen.

#### Hint

- You can turn the jog dial to select a track and press the ENTER button to play the selected track.
- To return to the playback screen, press the BACK button.
- If you do not operate the HDD AUDIO PLAYER for about 15 seconds, the Play Queue screen closes and returns to the playback screen automatically.

---

[57] Settings menus

## Network Settings

---

[Connecting to a network \(Internet Settings\)](#)

[Viewing the network status \(View Network Status\)](#)

[Changing the device name of the HDD AUDIO PLAYER that is displayed on a network \(Device Name\)](#)

---

[58] Settings menus

## HDD Settings

---

[Viewing the hard disk drive status \(View HDD Status\)](#)

[Rescanning a hard disk drive \(Rescan HDD\)](#)



Formatting an external hard disk drive (Format External HDD)

Removing the external hard disk drive safely (Remove External HDD Safely)

---

[59] Settings menus

## Audio Settings

---

Using the DSEE function

Using the Gapless Playback function (Gapless Playback)

Using the Volume Normalization function (Volume Normalization)

Stopping the DSD Remastering function (DSD Remastering)

Switching the oversampling function (Oversampling)

---

[60] Settings menus

## Amp Control Settings

---

Operating a Sony amplifier using the remote control or dedicated application

Operating an amplifier manufactured by another company using the supplied remote control or a dedicated application

---

[61] Settings menus

## System Settings

---

Selecting the language to be displayed on the screen (Language)

Controlling the brightness (Brightness)

---

[Setting the Network Standby function \(Network Standby\)](#)

[Setting the Auto Standby function \(Auto Standby\)](#)

[Setting the Sleep timer \(Sleep\)](#)

[Receiving notifications about software updates \(Software Update Notification\)](#)

[Displaying the current system information \(System Information\)](#)

[Displaying the software license \(Software License\)](#)

[Resetting to the factory default \(Factory Reset\)](#)

---

[62] Settings menus

## Network Update

---

[Updating the software \(Network Update\)](#)

---

[63] Backups

## Backing up data

---

We recommend you arbitrarily have a backup of contents stored on the hard disk drive of the HDD AUDIO PLAYER, which are copies of contents on your computer.

If you do not have the original data on your computer anymore, we recommend you copy the contents in the hard disk drive of the HDD AUDIO PLAYER to your computer to have a backup.

Make sure you have a back up before sending the HDD AUDIO PLAYER for repair.

For details on how to copy music files from the HDD AUDIO PLAYER to your computer as a backup, check the topics listed as related topics below.

---

[64] Backups

## Backing up music files in the HDD AUDIO PLAYER to your computer (for Windows)

---

It is recommended that you copy music files in the HDD AUDIO PLAYER to your computer as a backup before you bring the HDD AUDIO PLAYER for repair or if you do not have the original music files in your computer.

You need to use the HAP Music Transfer application installed in your computer for the backup. Make sure that the HDD AUDIO PLAYER is turned on.

1. Open the context menu of HAP Music Transfer from  (the HAP Music Transfer icon) on the task tray of your computer and then select [Explore HAP].  
The Explorer window opens and icon(s) of the available shared folder(s) appear. ([HAP\_Internal] appears for the internal hard disk drive and [HAP\_External] appears for the external hard disk drive if one is connected.)
2. Select [HAP\_Internal] (to select the internal hard disk drive) or [HAP\_External] (to select the external hard disk drive), and then keep selecting folders until you reach the folder that contains the music files you want to back up.
3. Copy the music files from the HDD AUDIO PLAYER to the desired folder in your computer by drag and drop.

#### Note

- Do not transfer music files while backing up music files in Explorer using HAP Music Transfer.
- Do not transfer music files from your smartphone or tablet while backing up music files in Explorer.
- Set the [Auto Standby] function of the HDD AUDIO PLAYER to [Off] when you make a backup.

#### Hint

- If you want to back up all of the content in the internal or external hard disk drive, copy all of the folders (or files) that are located directly under [HAP\_Internal] or [HAP\_External] to your computer.

---

[65] Backups

## Backing up music files in the HDD AUDIO PLAYER to your computer (for Mac)

---

It is recommended that you copy music files in the HDD AUDIO PLAYER to your computer as a backup before you bring the HDD AUDIO PLAYER for repair or if you do not have the

original music files in your computer.

You need to use the HAP Music Transfer application installed in your computer for the backup. Make sure that the HDD AUDIO PLAYER is turned on.

1. Open the context menu of HAP Music Transfer from  (the HAP Music Transfer icon) on the Dock of your computer and then select [Explore HAP].  
The Finder opens and icon(s) of the available shared folder(s) appear. ([HAP\_Internal] appears for the internal hard disk drive and [HAP\_External] appears for the external hard disk drive if one is connected.)
2. Select [HAP\_Internal] (to select the internal hard disk drive) or [HAP\_External] (to select the external hard disk drive), and then keep selecting folders until you reach the folder that contains the music files you want to back up.
3. Copy the music files from the HDD AUDIO PLAYER to the desired folder in your computer by drag and drop.

#### Note

- Do not transfer music files while backing up music files in the Finder using HAP Music Transfer.
- Do not transfer music files from your smartphone or tablet while backing up music files in the Finder.
- Set the [Auto Standby] function of the HDD AUDIO PLAYER to [Off] when you make a backup.

#### Hint

- If you want to back up all of the content in the internal or external hard disk drive, copy all of the folders (or files) that are located directly under [HAP\_Internal] or [HAP\_External] to your computer.

---

[66] Backups

## Returning backup music files from your computer to the HDD AUDIO PLAYER (for Windows)

---

If you want to return music files you have copied to your computer as a backup to the HDD AUDIO PLAYER, follow the steps below.

You need to use the HAP Music Transfer application installed in your computer for returning backup files. Make sure that the HDD AUDIO PLAYER is turned on.

1. Open the context menu of HAP Music Transfer from  (the HAP Music Transfer icon) on the task tray of your computer and then select [Explore HAP].  
The Explorer window opens and icon(s) of the available shared folder(s) appear. ([HAP\_Internal] appears for the internal hard disk drive and [HAP\_External] appears for the external hard disk drive if one is connected.)
2. Select [HAP\_Internal] (to select the internal hard disk drive) or [HAP\_External] (to select the external hard disk drive), and then keep selecting folders until you reach the folder of the music files you want to restore.
3. Copy the music files from your computer to the HDD AUDIO PLAYER by drag and drop.

#### Note

- Do not transfer music files while returning backup files from your computer to the HDD AUDIO PLAYER using HAP Music Transfer.
- Do not transfer music files from your smartphone or tablet while returning backup files from your computer to the HDD AUDIO PLAYER.
- Do not return backup files from two or more computers at the same time.

#### Hint

- If you want to return the backup files of all of the content in the internal or external hard disk drive, select the backup folder and check “Watch” in the Contents Settings window of HAP Music Transfer. Go to the Transfer Settings window and select [Clear] for the [Transferred Files List] configuration to delete the transfer history, and then automatically or manually transfer the files.

---

## [67] Backups

# Returning backup music files from your computer to the HDD AUDIO PLAYER (for Mac)

---

If you want to return music files you have copied to your computer as a backup to the HDD AUDIO PLAYER, follow the steps below.

You need to use the HAP Music Transfer application installed in your computer for returning backup files. Make sure that the HDD AUDIO PLAYER is turned on.

1. Open the context menu of HAP Music Transfer from  (the HAP Music Transfer icon) on the Dock of your computer and then select [Explore HAP].  
The Finder opens and icon(s) of the available shared folder(s) appear. ([HAP\_Internal] appears for the internal hard disk drive and [HAP\_External] appears for the external

hard disk drive if one is connected.)

2. Select [HAP\_Internal] (to select the internal hard disk drive) or [HAP\_External] (to select the external hard disk drive), and then keep selecting folders until you reach the folder of the music files you want to restore.
3. Copy the music files from your computer to the HDD AUDIO PLAYER by drag and drop.

#### Note

- Do not transfer music files while returning backup files from your computer to the HDD AUDIO PLAYER using HAP Music Transfer.
- Do not transfer music files from your smartphone or tablet while returning backup files from your computer to the HDD AUDIO PLAYER.
- Do not return backup files from two or more computers at the same time.

#### Hint

- If you want to return the backup files of all of the content in the internal or external hard disk drive, select the backup folder and check “Watch” in the Contents Settings window of HAP Music Transfer. Go to the Transfer Settings window and select [Clear] for the [Transferred Files List] configuration to delete the transfer history, and then automatically or manually transfer the files.

---

[68] Specifications/Notes

## Playable audio file formats

---

The following audio file formats can be played on the HDD AUDIO PLAYER.

### **DSD (DSF, DSDIFF)**

Extensions: .dsf, .diff

Sampling frequency: 2.8224 MHz, 5.6448 MHz

### **LPCM (WAV, AIFF)**

Extensions: .wav, .aif, .aiff

Sampling frequency: 44.1 kHz, 48 kHz, 88.2 kHz, 96 kHz, 176.4 kHz, 192 kHz

Quantization bits: 16 bits, 24 bits, 32 bits (\*)

\* 32-bit playback is only possible for files in WAV format.

### **FLAC**

Extensions: .flac, .fla

Sampling frequency: 44.1 kHz, 48 kHz, 88.2 kHz, 96 kHz, 176.4 kHz, 192 kHz

Quantization bits: 16 bits, 24 bits

### **ALAC**

Extensions: .m4a

Sampling frequency: 44.1 kHz, 48 kHz, 88.2 kHz, 96 kHz, 176.4 kHz, 192 kHz

Quantization bits: 16 bits, 24 bits

### **MP3 (MPEG-1/2 Audio Layer-3)**

Extensions: .mp3

Bit rate: 64 kbps - 320 kbps

Sampling frequency: 44.1 kHz, 48 kHz

Quantization bits: 16 bits

### **AAC (MPEG-4 AAC-LC, HE-AAC)**

Extensions: .m4a, .mp4, .3gp

Bit rate: 64 kbps - 320 kbps

Sampling frequency: 44.1 kHz, 48 kHz

Quantization bits: 16 bits

### **WMA (WMA, WMAPro, WMA Lossless)**

Extensions: .wma, .asf

Bit rate: 32 kbps - 320 kbps (WMA, WMAPro)

Sampling frequency: 44.1 kHz, 48 kHz (WMA)

Sampling frequency: 44.1 kHz, 48 kHz, 88.2 kHz, 96 kHz (WMAPro, WMA Lossless)

Quantization bits: 16 bits (WMA, WMAPro)

Quantization bits: 16 bits, 24 bits (WMA Lossless)

### **ATRAC (ATRAC3, ATRAC3plus, ATRAC Advanced Lossless)**

Extensions: .oma, .aa3

Bit rate: 48 kbps - 352 kbps (ATRAC3plus)

Bit rate: 132 kbps (ATRAC3)

Sampling frequency: 44.1 kHz

Quantization bits: 16 bits

#### **Note**

- No copy protected files in any of the above formats can be played. If you transfer copy protected files to the HDD AUDIO PLAYER, music information of the copy protected files will appear in gray and you will not be able to select it.
  - Only 2ch files in the above formats are supported.
  - Playing formats other than those above may produce noise or even damage the speakers if played at a high volume.
-

## Design and specifications

---

### **Playback Specifications**

Frequency response: 2 Hz - 80 kHz (−3 dB)

Dynamic range: 105 dB or higher

THD: 0.0015% or less

### **Network section**

#### **Wired LAN**

1000BASE-T/100BASE-TX/10BASE-T

#### **Wireless LAN**

Compatible standards: IEEE 802.11 b/g/n

Frequency band/channel: 2.4 GHz band, channels 1-11 (models for the USA and Canada), channels 1-13 (models for Europe)

### **HDD section**

#### **Capacity**

1 TB (\*)

\* Some portions of the capacity are used for data management. Therefore, the capacity a user can use is less than 1 TB.

#### **Supported playback format**

DSD (DSF, DSDIFF), LPCM (WAV, AIFF), FLAC, ALAC, ATRAC Advanced Lossless, ATRAC, MP3, AAC, WMA (2 channels)

### **Jack section**

#### **Output jacks**

##### **LINE OUT UNBALANCED**

Output level: 2.0 Vrms (50 kilohms)

Impedance: 10 kilohms or higher

##### **LINE OUT BALANCED**

Output level: 2.0 Vrms (50 kilohms)

Impedance: 600 ohms or higher

#### **EXT port**

Type A USB, Hi-Speed USB, for connecting an external hard disk drive



## **IR REMOTE OUT jack**

for connecting the monaural mini-plug cable (supplied) or IR blaster (supplied)

## **General and others**

### **Power requirements**

Models for the USA and Canada: AC 120 V 60 Hz

Models for Europe: AC 230 V 50/60 Hz

### **Power consumption**

On: 35 W

During standby mode (when [Network Standby] is set to [Off]): 0.3 W

During standby mode (when [Network Standby] is set to [On] and a wired LAN is used): 2.6 W

During standby mode (when [Network Standby] is set to [On] and a wireless LAN is used): 2.8 W

### **Dimensions (approx.) (w/h/d)**

430 mm × 130 mm × 390 mm (17 in. × 5 1/8 in. × 15 3/8 in.) including projecting parts and controls

### **Mass (approx.)**

14.5 kg (32 lbs 0 oz)

### **Supplied accessories**

See "[Supplied accessories.](#)"

Design and specifications are subject to change without notice.

---

[70] Specifications/Notes

## **Software updates for the HDD AUDIO PLAYER**

---

When updating the software of the HDD AUDIO PLAYER is possible by performing the Network Update function, [A new version of the software is available. Update the software now? To update later, go to the "Settings" menu and select "Network Update". For details on updates, see the Sony website.] you will be notified on the screen: (The HDD AUDIO PLAYER is set to notify you of updates, as the [Software Update Notification] function is set to [On] as the factory default setting).

By updating the software, you can update the HDD AUDIO PLAYER functions.

When the above message appears, select either [Now] or [Later] to update the HDD AUDIO PLAYER.

- If you have selected [Now]: Follow the instructions that appear on the screen to update

the software.



- If you have selected [Later]: Select [Settings] - [Network Update] from the Home screen to update the software.

---

[71] Specifications/Notes

## When registering music files to the HDD AUDIO PLAYER

---

- When music files are transferred to the HDD AUDIO PLAYER, a counter indicating the number of transferred and unanalyzed music files appears beside  (the icon that indicates the transfer and registration status).
- Once music files are transferred, the HDD AUDIO PLAYER starts analyzing files and registering them to the HDD AUDIO PLAYER. When music files are registered, the number shown in the counter beside  decreases. When all of the music files are registered to the HDD AUDIO PLAYER, the counter disappears.
- While the HDD AUDIO PLAYER is analyzing music files,  is displayed.

### **Maximum number of music files that can be registered (operation guaranteed number of music)**

The HDD AUDIO PLAYER supports handling of up to 20,000 music files.

---

[72] Specifications/Notes

## Precautions on heat buildup

---

Although the HDD AUDIO PLAYER heats up during operation, this is not a malfunction. The temperature of the top, sides and bottom of the cabinet rises considerably. To avoid burning yourself, do not touch the cabinet.

Do not place the HDD AUDIO PLAYER on a device that produces heat, such as an amplifier. Also, do not place the HDD AUDIO PLAYER in a closed area. To prevent heat buildup inside the HDD AUDIO PLAYER, use the HDD AUDIO PLAYER in a well-ventilated place.

---

[73] Specifications/Notes

## Notes on the internal hard disk drive

---

The hard disk drive allows you to store large volumes of data or data with long recording times and play back data from your desired part with ease.

Keep in mind the following cautions.

- Do not apply physical shock or vibration to the HDD AUDIO PLAYER. Do not place the HDD AUDIO PLAYER in an unstable place.
- Do not impose a sudden temperature change (10°C (50°F) or more /hour) to the HDD AUDIO PLAYER. Doing so may cause moisture condensation.
- Disconnect the AC power plug from the wall outlet (wall socket) before moving the HDD AUDIO PLAYER.
- Make sure of the following before unplugging the AC power plug.
  - 1 minute has passed since you turned off the HDD AUDIO PLAYER.
  - The LCD screen is turned off.
- Do not replace or add hard disk drives on the HDD AUDIO PLAYER. Doing so may cause a malfunction.
- Your data cannot be restored if the hard disk drive is broken from any cause.
- Due to the nature of the hard disk drive, we do not recommend you store data on the hard disk drive for a long period.

## **About repairing the internal hard disk drive**

- When conducting repairs or diagnostic checks, it may be necessary to access data stored on the hard disk drive for repair and testing purposes to verify how a problem occurred and to determine possible remedies. However, titles of files or any other information will not be duplicated or saved by Sony.
- If replacement or initialization is required, the hard disk drive will be formatted at our discretion. Be aware that all of the existing data on the hard disk drive will be erased (data covered by copyright laws).
- In regards to storage and disposal of the replaced hard disk drive, Sony will employ strict controls within reasonable limits, and assume full responsibility to ensure that third parties, including business partners to whom the storage and disposal work is delegated, do not mishandle the data on the hard disk drive.

## **Disclaimer on compensation for lost recordings**

Sony is not liable and will not compensate for any lost recordings or related losses, including when recordings are not made on the HDD AUDIO PLAYER or external media/recording device due to reasons including HDD AUDIO PLAYER failure, or when the data of a recording is lost or damaged as a result of the HDD AUDIO PLAYER or external media/recording device failure or repair undertaken to the HDD AUDIO PLAYER. Sony will not restore, recover, or replicate the data under any circumstances.

We recommend you appropriately back up data stored on the hard disk drive of the HDD AUDIO PLAYER, which are copies of data on your computer.

If you do not have the original data on your computer anymore, we recommend you copy the data on the hard disk drive of the HDD AUDIO PLAYER to your computer and back that up. Make sure you back up your data as stated above before sending the HDD AUDIO PLAYER for repair.

For details on how to copy contents in the hard disk drive of the HDD AUDIO PLAYER to your computer, refer to the topics in the related links shown below.

---

[74] Specifications/Notes

## Precautions for use

---

### Precautions when disconnecting the AC power cord

Make sure that the HDD AUDIO PLAYER is in the standby mode when you disconnect the AC power cord (mains lead) from a wall outlet (mains).

If you disconnect the AC power cord (mains lead) during operation, a loss of data or malfunction may occur.

### Cleaning

Clean the cabinet, panels, and controls with a soft, dry cloth. Do not use any type of abrasive pad, scouring powder, or solvent such as alcohol or benzene.

If you have any questions or problems concerning the HDD AUDIO PLAYER, please consult your nearest Sony dealer.

---

[75] Specifications/Notes

## Trademarks

---

- ATRAC, ATRAC3, ATRAC3plus, ATRAC Advanced Lossless and their logos are trademarks of Sony Corporation.
- “DSEE” is a registered trademark of Sony Corporation.
- SensMe™ and the SensMe™ logo are trademarks or registered trademarks of Sony Mobile Communications AB.
- Microsoft, Windows, Windows Vista and Windows Media are either trademarks or registered trademarks of Microsoft Corporation in the United States and/or other countries.

This product is protected by certain intellectual property rights of Microsoft Corporation. Use or distribution of such technology outside of this product is prohibited without a

license from Microsoft or an authorized Microsoft subsidiary.

- MPEG Layer-3 audio coding technology and patents licensed from Fraunhofer IIS and Thomson.
- Mac, Mac OS and iTunes are trademarks of Apple Inc., registered in the U.S. and other countries.
- iPhone, iPad and iPod touch are trademarks of Apple Inc., registered in the U.S. and other countries.
- IOS is a trademark or registered trademark of Cisco in the U.S. and other countries and is used under license.
- Google Play, Android, YouTube and their respective logos are trademarks of Google Inc.
- Wi-Fi®, Wi-Fi Protected Access® and Wi-Fi Alliance® are registered marks of the Wi-Fi Alliance.
- Wi-Fi CERTIFIED™, WPA™, WPA2™ and Wi-Fi Protected Setup™ are marks of the Wi-Fi Alliance.



- Gracenote®, Gracenote logo and logotype, and the “Powered by Gracenote” logo are either a registered trademark or a trademark of Gracenote, Inc. in the United States and/or other countries.



T-1380009

All other trademarks and registered trademarks are trademarks or registered trademarks of their respective holders. In this Help Guide, TM and ® marks are not specified.

---

[76] Troubleshooting

## General

---

The power is automatically turned off.

The power is automatically turned on.

The remote control does not work.

You cannot operate the connected Sony amplifier or an amplifier from another manufacturer.

Cannot transfer music files via HAP Music Transfer.

You want to transfer music files to the HDD AUDIO PLAYER by dragging and dropping but do not know how. (for Windows)

You want to transfer music files to the HDD AUDIO PLAYER by dragging and dropping but do not know how. (for Mac)

Cannot operate the HDD AUDIO PLAYER through HDD Audio Remote.

The HDD AUDIO PLAYER responds slowly to operations.

A clicking sound is heard from inside the HDD AUDIO PLAYER.

---

[77] Troubleshooting

## Sound/playback

---

No sound is output or sound is interrupted.

There is severe humming or noise.

Cannot play tracks.

Some tracks are not displayed.

Playback stopped.

Tracks belonging to the same album are registered to different albums.

Tracks belonging to different albums are registered to one album.

The album art image displayed on the HDD AUDIO PLAYER is different from that displayed in the music file management software on your computer or does not display.

The track name or album name displayed on the HDD AUDIO PLAYER is different from that displayed in the music file management software on your computer or does not display.

When you attempt to obtain music information, merge albums or edit SensMe™ channels, an error message is displayed and you cannot perform the operation.

Cannot connect to Internet radio, or some stations or programs are interrupted at certain times of day.

When operating TuneIn, [Current operation not available due to account restrictions.] appears.

---

[78] Troubleshooting

## Connections

---

Your computer cannot connect to the network after you press the WPS button.

You cannot connect to the network or the network connection is unstable.

The wireless router you want to connect to is not shown in the wireless network list.

It takes a long time to transfer and register music files to the HDD AUDIO PLAYER.

You want to turn off the Wi-Fi (wireless LAN) function but do not know how.

---

[79] Troubleshooting

## Hard disk drive

---

The external hard disk drive is not recognized.

Some music files are not transferred.

An external hard disk drive that has been used with the HDD AUDIO PLAYER cannot be used with your computer.

You want to delete music files but do not know how.

The information of an external hard disk drives does not appear on the HDD AUDIO PLAYER.

[Unformatted external HDD has been connected. Format the HDD?] appears when you connect an external hard disk drive to the EXT port on the rear panel of the HDD AUDIO PLAYER.

---

[80] Troubleshooting

## Help for HAP Music Transfer/HDD Audio Remote

---

Help for HAP Music Transfer or HDD Audio Remote can be displayed from the following website.

<http://rd1.sony.net/help/ha/hap1/>

---

[81] Troubleshooting

## If the problem is not solved

---

Using the Clear Database function or the Reset to Default Settings function (Special Mode)

Resetting to the factory default

Customer support websites

---

[82] Dealing with problems/Inquiries

## Standby modes

---

The HDD AUDIO PLAYER has two types of standby mode: normal standby mode and Network Standby mode.

### **Standby mode**

Press the  button to switch to standby mode so that you can save power.

(The HDD AUDIO PLAYER enters this standby mode if the Network Standby mode is disabled. The HDD AUDIO PLAYER cannot be operated through the network.)

### **Network Standby mode**

In this mode, the network function is activated even when the HDD AUDIO PLAYER is in



standby mode.

This function is useful in the following cases:

- When music files are transferred to the HDD AUDIO PLAYER using the HAP Music Transfer application.
- When you want to launch the HDD AUDIO PLAYER from the HDD Audio Remote application.

Select [Settings] - [System Settings] - [Network Standby] from the menu to set the Network Standby mode.

#### Note

- The HDD AUDIO PLAYER does not enter standby mode when music files are being transferred from your computer, smartphone or tablet or when the HDD AUDIO PLAYER is analyzing transferred music files, even if you press the  $\text{I/O}$  button to switch to standby mode. The HDD AUDIO PLAYER enters standby after all target music files are transferred and analyzed.

#### Hint

- The HDD AUDIO PLAYER enters the Network Standby mode after 20 minutes of no operations and no playback if [Auto Standby] is set to [On] (factory default setting).

---

[83] Dealing with problems/Inquiries

## Forced shutdown of the HDD AUDIO PLAYER

---

In the rare case of an unusual situation, such as if the HDD AUDIO PLAYER does not respond to operations of the buttons and controls, you can forcibly turn the power off. You do not need to forcibly shut down the HDD AUDIO PLAYER in normal use.

1. Press and hold  $\text{I/O}$  on the HDD AUDIO PLAYER for 5 seconds or more.  
The power lamp flashes three times and then the power turns off.  
After a while, the HDD AUDIO PLAYER is automatically rebooted and enters the standby mode or the Network Standby mode.

#### Note

- If you forcibly shut down the HDD AUDIO PLAYER while music files are being transferred, the files or setting configurations may not be saved in or applied to the HDD AUDIO PLAYER.
-

## Messages for protecting the HDD AUDIO PLAYER

---

If the HDD AUDIO PLAYER detects an abnormality inside the unit, one of the following messages appears for about 5 seconds and then the HDD AUDIO PLAYER automatically enters the standby mode.

### Note

- The HDD AUDIO PLAYER enters the normal standby mode, even if the Network Standby mode is set to [On].

### HDD PROTECTOR

The internal temperature of the HDD AUDIO PLAYER is too high. Turn the power off and remove any objects covering the HDD AUDIO PLAYER. Wait until the HDD AUDIO PLAYER cools down sufficiently and then turn the power on again.

### USB PROTECTOR

An abnormal current is being output to the EXT port on the rear of the HDD AUDIO PLAYER. Turn the power off, confirm the connection and then turn the power on again.

### CPU PROTECTOR

The internal temperature of the HDD AUDIO PLAYER is too high. Turn the power off and remove any objects covering the HDD AUDIO PLAYER. Wait until the HDD AUDIO PLAYER cools down and then turn the power on again.

---

## Other messages

---

If the HDD AUDIO PLAYER detects an abnormality in the internal or external hard disk drives, one of the following messages appears.

### **Cannot complete formatting. Some errors were found in the HDD.**

A malfunction may have occurred in the external hard disk drive. Use another external hard disk drive.

### **Cannot complete rescanning. Some errors were found in the HDD.**

The following may be reasons for the malfunction.

- A file not supported by the HDD AUDIO PLAYER is saved on the internal or external hard disk drive.
- An abnormality occurred in the database.

- A malfunction has occurred in the internal or external hard disk drive.

If you cannot solve the problem, try the following:

- Format the external hard disk drive (\*1).
- Select [Special Mode] - [Clear Database], and then rescan the hard disk drive.
- If the problem still persists, use another external hard disk drive or perform the Factory Reset function on the HDD AUDIO PLAYER, referring to “[Resetting to the factory default \(Factory Reset\)](#)” (\*2).

\*1 By formatting, all of the content stored on the external hard disk drive will be deleted.

\*2 If you perform the Factory Reset function, all settings you have configured and all of the content stored on the internal hard disk drive will be deleted. (Sample tracks saved on the internal hard disk drive by default remain.)

---

[86] Dealing with problems/Inquiries

## When a notification about a new version of the software appears on the display

---

When a new version of the HDD AUDIO PLAYER software is available through the Network Update function, the message [A new version of the software is available. Update the software now? To update later, go to the "Settings" menu and select "Network Update". For details on updates, see the Sony website.] is displayed. (The [Software Update Notification] function is set to [On] by default to display this notification.)

The functions of the HDD AUDIO PLAYER can be updated to the latest version by performing the Network Update function.

To update the software, select either [Now] or [Later].

- If you have selected [Now]: Follow the instructions that appear on the screen to update the software.
- If you have selected [Later]: Select [Settings] - [Network Update] from the Home screen to update the software.

---

[87] Dealing with problems/Inquiries

## Customer support websites

---

Please access the following support websites for information on your HDD AUDIO PLAYER.

**For customers in the USA:**

<http://esupport.sony.com/>

**For customers in Canada:**

<http://esupport.sony.com/CA/>

**For customers in Europe:**

[www.sony.eu/support](http://www.sony.eu/support)

---

## Connecting to a network (Internet Settings)

---

You can connect the HDD AUDIO PLAYER to the network you are using through a wired LAN or Wi-Fi (wireless LAN).

There are multiple connection methods. Select a suitable connection method for the network you are using.

**Hint**

- A wired LAN connection enables you to transfer music files more quickly.  
Using a wired LAN is especially recommended when transferring large volumes of data, such as when transferring music files stored on your computer to the HDD AUDIO PLAYER for the first time.
- The Wi-Fi (wireless LAN) function of the HDD AUDIO PLAYER turns off when you select the wired LAN setting.

1. Select [Settings] - [Network Settings] in the Home screen.
2. Select [Internet Settings].
3. Select the desired method of connection.
  - In the case of [Wired Setup]:  
There are two connection methods: automatic connection and manual connection.
  - In the case of [Wireless Setup]:  
There are four connection methods: using the WPS push button configuration, selecting an access point, adding a new access point and using the (WPS) PIN code configuration.

Refer to each related topic for details of each connection method.

4. Follow the instructions on the screen to connect to the network.
-

# Viewing the network status (View Network Status)

---

You can view the current network status of the HDD AUDIO PLAYER.

You can confirm various settings of the current network such as the connection method, wired/wireless connection status, internet access, network service set identifier (SSID), IP address settings, DNS settings and MAC address.

1. Select [Settings] - [Network Settings] in the Home screen.

2. Select [View Network Status].

A screen indicating various network status items appears. When you have confirmed the network status, select [Close] to close the screen.

---

# Changing the device name of the HDD AUDIO PLAYER that is displayed on a network (Device Name)

---

You can edit the device name of the HDD AUDIO PLAYER that is displayed on a network.

1. Select [Settings] - [Network Settings] in the Home screen.

2. Select [Device Name].

The current network device name is displayed.

3. When the input space for the network device name is surrounded by a white box, press ENTER.

An editing display and keyboard appear.

4. Edit the network device name.

You can enter a maximum of 15 alphanumeric characters and/or symbols for a network device name.

For details on how to use the keyboard, see "[How to input characters.](#)"

When the editing is done, the screen returns to the step 3.

5. When the desired network device name is displayed, select [OK].

The edited network device name is registered.

## Hint

- If you select [Cancel] or press the BACK button in step 5, the edited network device name

is not registered.

---

## Viewing the hard disk drive status (View HDD Status)

---

You can confirm the total capacity, used space and free space of the internal and external hard disk drives.

1. Select [Settings] - [HDD Settings] in the Home screen.

2. Select [View HDD Status].

A screen indicating the status of the internal and external hard disk drives appears.

When you have confirmed the hard disk drive status, select [Close] to close the screen.

### Descriptions of display items

Information about the internal and external hard disk drives is displayed.

#### Internal HDD (HAP\_Internal) /External HDD (HAP\_External) :

The type of internal or external hard disk drive is displayed on the volume label. The label of the external hard disk drive changes according to the status, such as [Not Connected] if no external hard disk drive is connected, [Unformatted] if the hard disk drive is not formatted, or [Not Available] if the hard disk drive is not available. The file system is also displayed for external hard disk drives.

#### Capacity:

The total capacity of the hard disk drive is displayed.

#### Used:

The used space of the hard disk drive is displayed. The used space in the hard disk drive will not be 0 GB even when you have not transferred any files, because the pre-installed sample tracks and the system use some space in the hard disk drive.

#### Free:

The free space of the hard disk drive is displayed.

#### Hint

- When an external hard disk drive is formatted, the file system becomes ext4.
  - You can use multiple external hard disk drives by removing one and inserting another.
- 

## Rescanning a hard disk drive (Rescan HDD)

---

You can forcibly match the content of a hard disk drive and the content displayed on the screen of the HDD AUDIO PLAYER by rescanning the hard disk drive.

For example, if the analysis of music files is interrupted by an unexpected reason such as a sudden power outage, a mismatch may occur between the content displayed on the screen of the HDD AUDIO PLAYER and the actual content stored in the external hard disk drive. In this case, rescan the hard disk drive to correct the difference between the content displayed on the screen and the current database of the hard disk drive.

1. Select [Settings] - [HDD Settings] in the Home screen.
2. Select [Rescan HDD].  
A screen to select the internal or external hard disk drive appears.
3. Select [Rescan Internal HDD] , [Rescan External HDD] or [Rescan External HDD (differing items)].  
A confirmation screen appears.
4. Select [Yes].  
Rescanning of the hard disk drive starts.
5. When rescanning of the hard disk drive is complete, select [OK].

#### Note

- Performing the Rescan HDD functions (except for the differing items scan) restores the information of the music files. Music information edited by HDD Audio Remote is therefore reset. However, playlist information (playback times, newly added, playlists made by HDD Audio Remote), the favorite status (  ) and edited SensMe™ channels information are kept.
- When starting to rescan the hard disk drive, playback of music files stops.
- If no external hard disk drive is connected, [Rescan External HDD] and [Rescan External HDD (differing items)] are disabled and grayed out in step 3.
- Do not turn the HDD AUDIO PLAYER off during rescanning.
- Do not disconnect the external hard disk drive during rescanning.
- You cannot operate the HDD AUDIO PLAYER during rescanning.

#### Hint

- If you use a computer to add or delete music files on an external hard disk drive that was previously connected to the HDD AUDIO PLAYER, then connect the external hard disk drive to the HDD AUDIO PLAYER again, perform [Rescan External HDD (differing items)]. Rescanning for differing items keeps music information, playlist information, the favorite status (  ) and edited SensMe™ channels information on the music files other than those that were added/deleted.

---

# Formatting an external hard disk drive (Format External HDD)

---

You can format an external hard disk drive.

After formatting, all of the content stored on the hard disk drive is deleted.

If formatting an external hard disk drive, be sure to confirm that it is connected properly.

1. Select [Settings] - [HDD Settings] in the Home screen.
2. Select [Format External HDD].  
A confirmation screen appears.
3. Select [Yes].  
Formatting of the hard disk drive starts.
4. When formatting of the hard disk drive is complete, select [OK].

## Note

- After formatting, the file system of the external hard disk drive becomes ext4.  
External hard disk drives that have been formatted by the HDD AUDIO PLAYER cannot be used on your computer (Windows/Mac). If you want to use the external hard disk drive with your computer, refer to the operating instructions of your computer's OS and format it on your computer.
- Do not turn the HDD AUDIO PLAYER off during formatting.
- Do not disconnect the external hard disk drive during formatting.
- You cannot operate the HDD AUDIO PLAYER during formatting.
- When starting to format the hard disk drive, playback of music files stops.
- If no external hard disk drive is connected, [Format External HDD] is disabled and grayed out in step 2.
- Formatting an external hard disk drive only deletes the database of the external hard disk drive currently connected to the HDD AUDIO PLAYER. The HDD AUDIO PLAYER keeps the information (database) of other external hard disk drives that have been used.

---

# Removing the external hard disk drive safely (Remove External HDD Safely)

---



You can safely remove external hard disk drives connected to the EXT port on the rear panel of the HDD AUDIO PLAYER.

1. Select [Settings] - [HDD Settings] in the Home screen.
2. Select [Remove External HDD Safely].  
A message confirming the safe removal appears on the screen.
3. Select [OK].
4. Disconnect the external hard disk drive.

#### Note

- If an error occurs, disconnect the external hard disk drive while the HDD AUDIO PLAYER is in the standby mode.
- Be sure to disconnect the external hard disk drive while the HDD AUDIO PLAYER is in the standby mode or perform the [Remove External HDD Safely] function. Otherwise, the data may be damaged.
- If no external hard disk drive is connected, [Remove External HDD Safely] is disabled and grayed out in step 2.

---

## Using the DSEE function

---

When the DSEE (Digital Sound Enhancement Engine) function is set to [Auto] (factory default setting), the HDD AUDIO PLAYER offers natural and expansive sound by restoring both high-frequency signals and fine fade-out sound that is likely to be lost by compression in compressed audio sources, or restoring fine fade-out sound that is likely to be lost by quantization in PCM audio sources with lossless compression.

The left figures are images of sound without using the DSEE function, and the right figures are images of sound using the DSEE function.

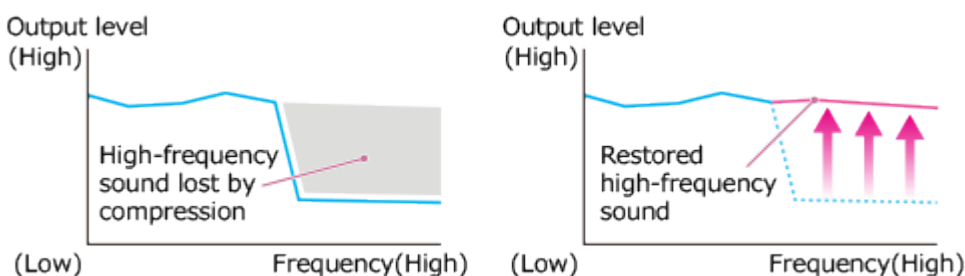

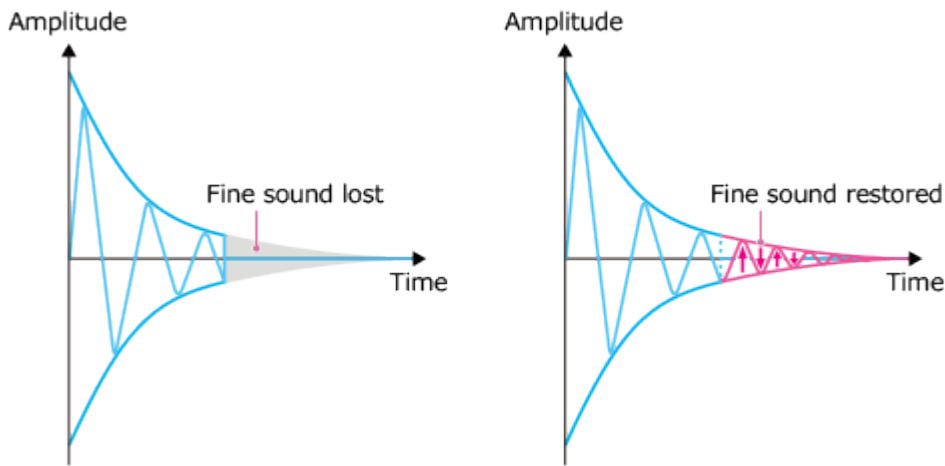

#### Note

- Only the fine sound restoration feature of the DSEE function will be applied to PCM audio sources with lossless compression. The DSEE function does not work for DSD (DSDIFF, DSF) format files.

#### Hint

- DSEE stands for Digital Sound Enhancement Engine, a high range compensation and fine sound restoration technology developed independently by Sony.
  1. Select [Settings] – [Audio Settings] from the Home screen.
  2. Select [DSEE ].
  3. Select [Auto].

The DSEE function automatically works for compressed audio sources and PCM audio sources with lossless compression. The DSEE lamp lights up while the DSEE function is active.

#### Hint

- You can also set this function using the Playback Options menu during playback.

---

## Using the Gapless Playback function (Gapless Playback)

---

When the Gapless Playback function is set to [Auto], the HDD AUDIO PLAYER plays tracks without the silent part between tracks. This is useful for playing albums of concerts or other live music.

The Gapless Playback function works with DSD, WAV, AIFF, FLAC, ALAC and WMA

Lossless music file formats.

1. Select [Settings] - [Audio Settings] in the Home screen.
2. Select [Gapless Playback].
3. Select a Gapless Playback setting from [Off] and [Auto].  
The gaps between tracks are adjusted according to the selected setting.

## Descriptions of menu settings

Selectable menu items are described below.

### Off:

The adjustment of gaps between tracks is not performed. The HDD AUDIO PLAYER plays tracks as they are.

### Auto:

The tracks are played back without gaps (factory default setting).

### Note

- Short gaps may occur even if the Gapless Playback function is set to [Auto], depending on the file format of the currently playing track and that of the next track to be played.
- The Gapless Playback function will be applied only when you play the tracks of an album in the original order.

---

## Using the Volume Normalization function (Volume Normalization)

---

If you set the Volume Normalization function to [Auto], the recording level of tracks or albums is analyzed when the music files are transferred and registered to the HDD AUDIO PLAYER, and the volume level is adjusted to minimize the difference in volume between each track or album during playback. Even if you play tracks from multiple albums with different volume levels in random order (shuffle play), this function stops the volume from increasing or decreasing for different tracks, allowing natural change in volume during playback. When this function is set to [Off] (factory default setting), the volume level is not adjusted.

1. Select [Settings] - [Audio Settings] in the Home screen.
2. Select [Volume Normalization].
3. Select [Auto].

**Note**

- The HDD AUDIO PLAYER must be connected to the Internet when analyzing music files using the Volume Normalization function in order to obtain music information from the Gracenote server.
- The volume level will not be adjusted for music files that the HDD AUDIO PLAYER cannot analyze.
- The volume level will not be adjusted for DSD format files as the DSD file format is not compatible with analysis.

---

## Stopping the DSD Remastering function (DSD Remastering)

---

When the DSD Remastering function is set to [Off], the HDD AUDIO PLAYER plays back the signal of sound sources without converting to a DSD signal.

Change this setting as you like.

1. Select [Settings] - [Audio Settings] in the Home screen.
2. Select [DSD Remastering].
3. Select [Off].

---

## Switching the oversampling function (Oversampling)

---

The HDD AUDIO PLAYER is equipped with an 8x oversampling digital filter (single-stage) which reduces quantization noise, achieving high quality sound playback.

1. Select [Settings] - [Audio Settings] in the Home screen.
2. Select [Oversampling].
3. Select your desired item from the menu.

### Descriptions of menu settings

Selectable menu items are described below.

**Normal:**

Normal setting.

**Precision:**

Precise calculations realize fine playback sound. Bit expansion processing is simultaneously optimized while the DSEE function is active, producing a more clear sound with improved S/N feeling.

**Note**

- This function does not work for DSD format files.

---

## Operating a Sony amplifier using the remote control or dedicated application

---

If you register the remote control supplied with a connected Sony amplifier to the HDD AUDIO PLAYER, you can perform operations such as turning on/off the amplifier, adjusting the volume and muting the sound through the remote control supplied with the HDD AUDIO PLAYER or the HDD Audio Remote application.

1. Select [Settings] - [Amp Control Settings] in the Home screen.
2. Confirm the description about the AMP Control Settings, and then select [Next].  
The current settings are displayed.
  - In use: a function to be used
  - Not in use: a function not to be used
3. Select [Next].  
A screen to select the manufacturer of the connected amplifier appears.
4. Select [Sony].  
A screen to confirm whether the amplifier has an IR In jack appears.
5. Select [Yes] or [No].
6. Select one of the connection methods below:
  - If there is an IR input jack on the amplifier, connect the IR REMOTE OUT jack of the HDD AUDIO PLAYER and the IR input jack of the amplifier with the monaural mini-plug cable (supplied).
  - If there is no IR input jack on the amplifier, connect the plug of the supplied IR

blaster (supplied) to the IR REMOTE OUT jack of the HDD AUDIO PLAYER, and place the other side of the IR blaster (the side to radiate infrared) close to the remote sensor of the amplifier.

7. Select [Next].

8. Select the remote code of the connected amplifier.

- If you are using a Sony 2ch amplifier, select [2ch Amplifier].
- If you are using a Sony AV amplifier, select [AV Receiver 1] or [AV Receiver 2] according to the remote code configured for the AV amplifier.

If you do not know which remote code should be set for your AV amplifier, select [AV Receiver 2] at first and confirm whether IR signal is output. If the AV amplifier does not work, select [AV Receiver 1]. Refer to the operating manual of the AV amplifier for details.

A list of settings appears.

9. Select a setting you want to configure.

10. Select [In use].

Select [Not in use] for items you do not want to set.

11. Select [Next].

12. Select [Test].

Select [Exit] if you do not want to test.

13. Confirm the instructions on the screen and then select [Start].

The connection test starts.

14. When you have confirmed that no problems have been found in the test, select [Exit].

#### Note

- If the HDD AUDIO PLAYER is turned off or in standby mode, you cannot adjust the volume or mute the amplifier using the remote control supplied with the HDD AUDIO PLAYER.

#### Hint

- You can also configure settings so that they are not controlled by the remote control, such as when you want to turn the power of the HDD AUDIO PLAYER off but do not want to turn the amplifier off.
- If you operate the connected amplifier using the remote control supplied with the HDD AUDIO PLAYER, operation of the amplifier may become inconsistent (operating at times but not operating at other times) due to interference of the remote control signal, especially if you continuously control the volume.

For example, if the infrared signal from the supplied remote control directly enters the

remote sensor (receiver) of the connected amplifier, interference may occur with the signal input from the IR input jack of the amplifier or the signal output from the installed IR blaster. This causes the amplifier to fail to receive the correct signal, resulting in inconsistent response from the amplifier.

In this case, place the amplifier in a location where it will not be affected by the infrared signal of the remote control of the HDD AUDIO PLAYER.

It is recommended that you use HDD Audio Remote, to avoid interference problems.

---

## Operating an amplifier manufactured by another company using the supplied remote control or a dedicated application

---

If you register the remote control supplied with a connected amplifier manufactured by another company to the HDD AUDIO PLAYER, you can perform operations such as turning on/off the amplifier, adjusting the volume and muting the sound through the remote control supplied with the HDD AUDIO PLAYER or the HDD Audio Remote application.

1. Select [Settings] - [Amp Control Settings] in the Home screen.
2. Confirm the description about the AMP Control Settings, and then select [Next].  
The current settings are displayed.
  - Not learned: a function that has not been learned yet
  - In use: a function that has been learned and is to be used
  - Not in use: a function that has been learned but is not to be used
3. Select [Next].  
A screen to select the manufacturer of the connected amplifier appears.
4. Select [Other].
5. Follow the instructions on the screen to connect the plug of the IR blaster (supplied) to the IR REMOTE OUT jack of the HDD AUDIO PLAYER and place the other side of the IR blaster (the side to radiate infrared) close to the remote sensor of the amplifier, and then select [Next].
6. Select a function you want the HDD AUDIO PLAYER to learn from functions indicated as [Not learned].  
The [Learning...] status appears.
7. While [Learning...] is displayed, aim the remote control of your amplifier at the remote

sensor of the HDD AUDIO PLAYER and press the button of the function being learned, such as the power button.

The HDD AUDIO PLAYER learns this function of the remote control of your amplifier. When the learning is completed, the Learning Complete screen appears.

8. If you want to test the connection to confirm that the learning has been completed, select [Yes].
9. Confirm the instructions on the screen and then select [Start].  
The connection test starts.
10. When you have confirmed that no problems have been found in the test, select [Finish Test].  
The screen returns to the list of the settings. If you want to configure another function, select the function and repeat the procedures from steps 6 to 10.
11. When configuration of the settings is completed, select [Exit].

#### Note

- If the HDD AUDIO PLAYER is turned off or in standby mode, you cannot adjust the volume or mute the amplifier using the remote control supplied with the HDD AUDIO PLAYER.
- The HOME and BACK buttons will not work while [Learning...] is displayed in step 7.
- This function is not necessarily compatible with all amplifiers from other manufacturers.

#### Hint

- You can also configure settings so that they are not controlled by the remote control, such as when you want to turn the power of the HDD AUDIO PLAYER off but do not want to turn the amplifier off.
- If you want to change the status of a function that has been learned and is to be used ([In use] is displayed), select [Not in use] in step 6.
- If you want the HDD AUDIO PLAYER to relearn a function that has been learned and is to be used ([In use] is displayed), select [Relearn] in step 6.
- If you operate the connected amplifier using the remote control supplied with the HDD AUDIO PLAYER, operation of the amplifier may become inconsistent (operating at times but not operating at other times) due to interference of the remote control signal, especially if you continuously control the volume.

For example, if the infrared signal from the supplied remote control directly enters the remote sensor (receiver) of the connected amplifier, interference may occur with the signal input from the IR input jack of the amplifier or the signal output from the installed IR blaster. This causes the amplifier to fail to receive the correct signal, resulting in inconsistent response from the amplifier.

In this case, place the amplifier in a location where it will not be affected by the infrared signal of the remote control of the HDD AUDIO PLAYER.



It is recommended that you use HDD Audio Remote, to avoid interference problems.

---

## Selecting the language to be displayed on the screen (Language)

---

Although you select the language to be displayed on the screen in the initial settings, you can also change the language later by following the steps below.

1. Select [Settings] - [System Settings] in the Home screen.
2. Select [Language].
3. [English] (factory default setting), [Español], [Français], [Deutsch] and [日本語].

### Hint

- The language setting does not affect the music information of files that are already registered.
- 

## Controlling the brightness (Brightness)

---

You can adjust the screen to your desired brightness to suit the brightness of your surroundings. If you set the brightness to [Off], the DSEE lamp goes off.

1. Select [Settings] - [System Settings] in the Home screen.
2. Select [Brightness].
3. Select your desired item from the menu.

### Descriptions of menu settings

Selectable menu items are described below.

#### Off:

The backlight of the display and the DSEE lamp are turned off. The power consumption is the lowest of all of the settings.

#### Low:

The backlight of the display is dim and the power consumption is low.

**Mid:**

The backlight of the display is set to medium brightness.

**High:**

The backlight of the display is bright and the power consumption is high.

**Max:**

The backlight of the display is at its brightest. The power consumption is the highest of all of the settings (factory default setting).

**Note**

- The power lamp lights up even if the brightness of the screen is set to [Off].
- If the brightness of the screen is set to [Off], the brightness of the backlight changes to [Low] for a fixed period of time when you start up the HDD AUDIO PLAYER or perform the operation on the screen.
- If the brightness of the screen is set to [Off], the brightness of the backlight briefly changes to [Low] during the following processes:
  - Updating the software
  - Formatting a hard disk drive
  - Rescanning a hard disk drive
  - Resetting the product (performing the Factory Reset function)
  - Displaying an alert message to notify the user of an operational error

---

## Setting the Network Standby function (Network Standby)

---

When you set the Network Standby function to [On], you can start up or operate the HDD AUDIO PLAYER via the network even when the HDD AUDIO PLAYER is in standby mode.

1. Select [Settings] - [System Settings] in the Home screen.
2. Select [Network Standby].
3. Select [On].

### Descriptions of menu settings

Selectable menu items are described below.

**On:**

The HDD AUDIO PLAYER is connected to the network at all times, even when the unit is turned off. This allows you to start up or operate the HDD AUDIO PLAYER from the HAP

Music Transfer or HDD Audio Remote application. This mode also reduces the startup time of the HDD AUDIO PLAYER.

**Off:**

The power consumption is lower than when the Network Standby function is set to [On], but the startup time when the HDD AUDIO PLAYER is turned on is longer (factory default setting).

---

## Setting the Auto Standby function (Auto Standby)

---



If you set the Auto Standby function to [On], if you do not operate the HDD AUDIO PLAYER and do not play tracks for approximately 20 minutes, the unit is automatically turned off and enters standby mode to reduce the power consumption.

1. Select [Settings] - [System Settings].
2. Select [Auto Standby].
3. Select [On] (factory default setting).

**Note**

- The Auto Standby function does not work during the following processes:
  - Updating the software
  - Formatting the hard disk drive
  - Rescanning a hard disk drive
  - Resetting the product (performing the Factory Reset function)
  - When the Sleep timer is working
  - Transferring music files from a computer

**Hint**

- When the remaining time until the HDD AUDIO PLAYER enters the standby mode is less than 60 seconds, the remaining time is shown on the screen.
- When the HDD AUDIO PLAYER is in standby mode, you can start the HDD AUDIO PLAYER by pressing the  button or  button on the remote control or the HDD AUDIO PLAYER, or by operating HDD Audio Remote (only when the HDD AUDIO PLAYER is in Network Standby mode).

---

## Setting the Sleep timer (Sleep)

---

You can set the Sleep timer. When the specific time you set has elapsed, the HDD AUDIO PLAYER is automatically turned off.

1. Select [Settings] - [System Settings].
2. Select [Sleep].
3. Set the specific time until the Sleep timer function activates from [Off] (factory default setting), [00:10], [00:20], [00:30], [00:40], [00:50], [01:00], [01:30] or [02:00].

#### Note

- The Auto Standby function that automatically turns the HDD AUDIO PLAYER off does not work after you set the Sleep timer.
- If the HDD AUDIO PLAYER is set to Network Standby mode, you can operate it through HDD Audio Remote even after the HDD AUDIO PLAYER has been turned off after the specific time you set has elapsed.
- The Sleep timer is canceled if one of the following operations is performed after setting the Sleep timer:
  - A software update is started.
  - Formatting of the hard disk drive is started.
  - Rescanning of the hard disk drive is started.
  - The HDD AUDIO PLAYER is manually turned off.
  - The product is reset. (The factory reset function is performed.)
  - The Sleep timer is set to off.

#### Hint

- When the remaining time until the sleep timer activates is less than 60 seconds, the remaining time is shown on the screen.
- You can set the Sleep timer from the Playback Options menu while playing a track.

---

## Receiving notifications about software updates (Software Update Notification)

---

If you set the Software Update Notification function to [On], a notification appears on the Home screen when a new version of the software is available.

1. Select [Settings] - [System Settings] in the Home screen.

2. Select [Software Update Notification].
3. Select [On] (factory default setting).

---

## Displaying the current system information (System Information)

---

You can confirm the current system information of the HDD AUDIO PLAYER including the software version, the network device name, the MAC address of the wired and wireless LAN, the device ID, the network connection status, your current IP address and the amount of free space on the internal and external hard disk drives.

1. Select [Settings] - [System Settings] in the Home screen.
2. Select [System Information].
3. When you have confirmed the current system information, select [Close].

---

## Displaying the software license (Software License)

---

This topic explains how to display the software license of the software installed on the HDD AUDIO PLAYER.

1. Select [Settings] - [System Settings] in the Home screen.
2. Select [Software License].
3. When you have confirmed the software license, select [Close].

---

## Resetting to the factory default (Factory Reset)

---

You can reset the HDD AUDIO PLAYER to the factory default settings. All settings you have configured and all of the content stored on the internal hard disk drive will be deleted.

(Sample tracks saved on the internal hard disk drive by default remain.)

1. Select [Settings] - [System Settings] in the Home screen.
2. Select [Factory Reset].
3. Select [Yes].  
The Factory Reset waiting screen appears.
4. When the Factory Reset complete screen appears, select [OK].  
When the Factory Reset is complete, the HDD AUDIO PLAYER restarts automatically.

#### Note

- If you perform the Factory Reset function while playing tracks, playback of the music files stops.
- If you perform the Factory Reset function while transferring music files, transfer of the music files stops.
- If you want to re-transfer music files that were transferred to the HDD AUDIO PLAYER before you performed the Factory Reset function, select the backup folder and check "Watch" in the Contents Settings window of HAP Music Transfer. Go to the Transfer Settings window and select [Clear] for [Transferred Files List] to delete the transfer history, and then automatically or manually transfer the files.

---

## Updating the software (Network Update)

---

You can update the software of the HDD AUDIO PLAYER.

To perform the Network Update function, be sure that the HDD AUDIO PLAYER is connected to the Internet.

1. Select [Settings] - [Network Update] in the Home screen.  
If a newer version of the software is found, a software update notification screen appears.
2. Confirm the current version of the software and the new version of the software, and then select [OK].  
The HDD AUDIO PLAYER connects to the network and starts downloading the new version of the software.  
Installation will start automatically after downloading is complete.

You can confirm the progress status on the screen.

After the software update is complete, the HDD AUDIO PLAYER restarts automatically.

#### Note

- Do not turn the HDD AUDIO PLAYER off or disconnect the LAN cable during the software update. This may cause a malfunction.
  - Select [Cancel] to cancel the software update while downloading the software.
  - If the software update fails, an update error screen appears and the HDD AUDIO PLAYER may restart.
  - If you update the software during playback, the playback stops.
- 

## The power is automatically turned off.

---

- If the [Auto Standby] function is set to [On], the HDD AUDIO PLAYER is automatically turned off after it is not operated for approximately 20 minutes.
  - If the sleep timer function is set, the HDD AUDIO PLAYER is automatically turned off when the specific time you set has elapsed.
  - If you use the HDD AUDIO PLAYER while it is placed on a device that produces heat (such as an amplifier), the temperature inside the HDD AUDIO PLAYER may rise and the power may be turned off to protect the HDD AUDIO PLAYER. Do not place the HDD AUDIO PLAYER on equipment that produces heat.
  - When the [Network Standby] function is set to [On], the HDD AUDIO PLAYER automatically turns on when a music file transfer is performed by HAP Music Transfer or the HDD Audio Remote application installed on your smartphone or tablet. The HDD AUDIO PLAYER turns off automatically when the music files are transferred and registered.
- 

## The power is automatically turned on.

---

- If the [Network Standby] function is set to [On], the HDD AUDIO PLAYER is turned on when it is operated through HDD Audio Remote or music files are transferred through HAP Music Transfer.
-

## The remote control does not work.

---

- Point the remote control at the remote sensor on the HDD AUDIO PLAYER.
  - Remove any obstructions in between the remote control and the HDD AUDIO PLAYER.
  - Replace all the batteries in the remote control with new ones if they are low.
- 

## You cannot operate the connected Sony amplifier or an amplifier from another manufacturer.

---

- If you operate the connected amplifier using the remote control supplied with the HDD AUDIO PLAYER, operation of the amplifier may become inconsistent (operating at times but not operating at other times) due to interference of the remote control signal, especially if you continuously control the volume.  
For example, if the infrared signal from the supplied remote control directly enters the remote sensor (receiver) of the connected amplifier, interference may occur with the signal input from the IR input jack of the amplifier or the signal output from the installed IR blaster. This causes the amplifier to fail to receive the correct signal, resulting in inconsistent response from the amplifier.  
In this case, place the amplifier in a location where it will not be affected by the infrared signal of the remote control of the HDD AUDIO PLAYER.  
It is recommended that you use HDD Audio Remote, to avoid interference problems.
  - Even if you configure the remote control supplied with the HDD AUDIO PLAYER so that it can operate equipment manufactured by other companies, the remote control may not work correctly depending on the manufacturer or manufacture year of the equipment.
- 

## Cannot transfer music files via HAP Music Transfer.

---

- Make sure that the HDD AUDIO PLAYER is turned on.
- Check the network connection.
- Make sure that the computer where the music files are stored is connected to the same network as the HDD AUDIO PLAYER.
- If the HDD AUDIO PLAYER is in normal standby mode, music files cannot be transferred via HAP Music Transfer. Set the HDD AUDIO PLAYER to the Network Standby mode.
- You may not be able to transfer files from HAP Music Transfer if your router is set to low



power consumption mode. In this case, disable the low power consumption mode of your router. For details, refer to the operating manual of your router.

- Depending on your network environment the HDD AUDIO PLAYER may not be displayed in the Connection window. For details, refer to the help guide of HAP Music Transfer.
- Try transferring the music files to the HDD AUDIO PLAYER by dragging and dropping. For details, refer to [“You want to transfer music files to the HDD AUDIO PLAYER by dragging and dropping but do not know how. \(for Windows\)”](#) or [“You want to transfer music files to the HDD AUDIO PLAYER by dragging and dropping but do not know how. \(for Mac\).”](#)

---

## You want to transfer music files to the HDD AUDIO PLAYER by dragging and dropping but do not know how. (for Windows)

---

1. Open the context menu of HAP Music Transfer from  (the HAP Music Transfer icon) on the task tray of your computer and then select [Explore HAP].

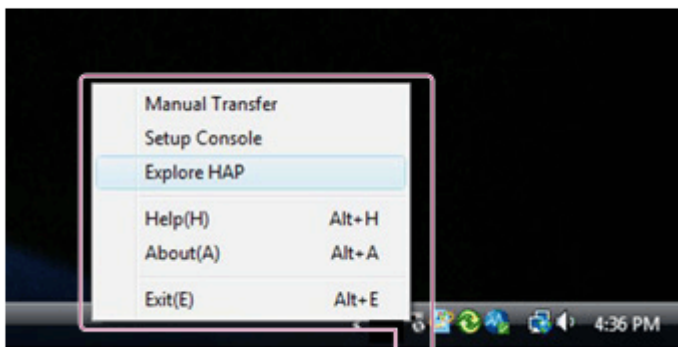

The Explorer window opens and icon(s) of the available shared folder(s) appear. ([HAP\_Internal] appears for the internal hard disk drive and [HAP\_External] appears for the external hard disk drive (if one is connected).)

2. Select [HAP\_Internal] (to select the internal hard disk drive) or [HAP\_External] (to select the external hard disk drive), and then open the folder that you want to transfer music files to.
3. Drag and drop music files from the computer to the HDD AUDIO PLAYER.

### Note

- Files that have file extensions which are not mentioned in [“Playable audio file formats”](#) do not appear on the list screen or cannot be played back by the HDD AUDIO PLAYER. They may take up unnecessary space on the hard disk drive.

- Do not transfer music files using HAP Music Transfer while also transferring music files to the HDD AUDIO PLAYER by dragging and dropping.
- Do not transfer music files from your smartphone or tablet while also transferring music files to the HDD AUDIO PLAYER by dragging and dropping.
- Do not transfer music files to the HDD AUDIO PLAYER by dragging and dropping from two or more computers at the same time.

---

## You want to transfer music files to the HDD AUDIO PLAYER by dragging and dropping but do not know how. (for Mac)

---

1. Open the context menu of HAP Music Transfer from  (the HAP Music Transfer icon) on the Dock of your computer and then select [Explore HAP].



The Finder opens and icon(s) of the available shared folder(s) appear. ([HAP\_Internal] appears for the internal hard disk drive and [HAP\_External] appears for the external hard disk drive (if one is connected).)

2. Select [HAP\_Internal] (to select the internal hard disk drive) or [HAP\_External] (to select the external hard disk drive), and then open the folder that you want to transfer music files to.
3. Drag and drop music files from the computer to the HDD AUDIO PLAYER.

### Note

- Files that have file extensions which are not mentioned in “[Playable audio file formats](#)” do not appear on the list screen or cannot be played back by the HDD AUDIO PLAYER. They may take up unnecessary space on the hard disk drive.
- Do not transfer music files using HAP Music Transfer while also transferring music files to the HDD AUDIO PLAYER by dragging and dropping.

- Do not transfer music files from your smartphone or tablet while also transferring music files to the HDD AUDIO PLAYER by dragging and dropping.
  - Do not transfer music files to the HDD AUDIO PLAYER by dragging and dropping from two or more computers at the same time.
- 

## Cannot operate the HDD AUDIO PLAYER through HDD Audio Remote.

---

- Make sure that the HDD AUDIO PLAYER is turned on.
  - Check the network connection.
  - Make sure that the smartphone/tablet where HDD Audio Remote is installed is connected to the same network as the HDD AUDIO PLAYER.
  - If the HDD AUDIO PLAYER is in normal standby mode, it cannot be operated through HDD Audio Remote. Set the HDD AUDIO PLAYER to the Network Standby mode.
  - You may not be able to operate your HDD AUDIO PLAYER with HDD Audio Remote if your router is set to low power consumption mode. In this case, disable low power consumption mode of your router. For details, refer to the operating manual of your router.
- 

## The HDD AUDIO PLAYER responds slowly to operations.

---

- The HDD AUDIO PLAYER responds slowly to operations performed on the HDD AUDIO PLAYER or by HDD Audio Remote while music files are being transferred or the HDD AUDIO PLAYER is analyzing and registering music files. This is not a malfunction.
- 

## A clicking sound is heard from inside the HDD AUDIO PLAYER.

---

- A clicking sound may be heard from inside the HDD AUDIO PLAYER while playing music files. This occurs when the HDD AUDIO PLAYER switches the sampling frequency, and

is not a malfunction.

---

## No sound is output or sound is interrupted.

---



- Check that the amplifier is connected to the HDD AUDIO PLAYER correctly.
  - Check that the amplifier connected to the HDD AUDIO PLAYER is not muted.
  - Check that both the HDD AUDIO PLAYER and the connected equipment are turned on.
  - Sound may be interrupted when the sampling frequency or audio format is changed.
  - Only 2ch tracks are supported in any of the playable file formats. Tracks other than 2ch tracks cannot be played.
  - DRM (Digital Rights Management)-protected music files cannot be played.
  - Confirm the audio file formats that can be played.
  - If the HDD AUDIO PLAYER is being used with a television, speakers, video deck or tape deck and is placed too close to that equipment, noise may result.
  - The input setting of the connected amplifier may not match the input jack to which the HDD AUDIO PLAYER is connected. Change the input setting of the amplifier.
  - If headphones are connected to the connected amplifier, sound is not output from the speakers.
  - If you are using an external hard disk drive, skipping may occur in the playback sound depending on the hard disk performance.
  - The HDD AUDIO PLAYER receives transferred files and analyzes music files at the same time. Start playback after the  icon disappears from the display.
- 

## There is severe humming or noise.

---

- Check whether the cords or cables are broken or have any other defects.
  - Check that the amplifier is connected to the HDD AUDIO PLAYER correctly.
  - Check that the connecting cords are not near a transformer, motor, TV set or fluorescent light.
  - Move your TV away from the HDD AUDIO PLAYER and other audio equipment.
  - The plugs and jacks are dirty. Wipe them with a cloth slightly moistened with alcohol.
- 

## Cannot play tracks.

- 
- The following tracks appear in gray and cannot be played:
    - Tracks that are not 2ch, even if the file extension is supported by the HDD AUDIO PLAYER.
    - Tracks that are identified as unplayable tracks by the HDD AUDIO PLAYER.
  - Tracks cannot be played if the music files are corrupted or the HDD AUDIO PLAYER fails to read the data because of vibration.
  - Tracks with  added will not be played, as these tracks are not entered in the Play Queue. For example, when you listen to all tracks in an album, tracks with  will not be included in the playback of that album. If you want to play a file with , select the track from the list directly.
  - Music files of a length of 2 seconds or less cannot be played back.

---

## Some tracks are not displayed.

---

- If you add  to tracks you dislike, the tracks are not displayed in the Play Queue.
- If tracks in a format that is not supported by the HDD AUDIO PLAYER are transferred without using HAP Music Transfer or the HDD Audio Remote application installed on your smartphone or tablet, these tracks are not displayed.

---

## Playback stopped.

---

- If you remove the external hard disk drive from the HDD AUDIO PLAYER during playback, the playback is stopped.
- If the currently playing audio file is deleted via the network during playback, the playback is stopped.
- If you change the favorite status of the currently playing track to , the playback is stopped.
- If you delete a track, album, or folder while playing, playback will be stopped. Playback will also be stopped if you delete a different track, album, or folder than the track currently playing.

---

## Tracks belonging to the same album are registered to

## different albums.

---

- The album name or album artist name embedded in the music files are different.
  - Select the target albums with HDD Audio Remote, and then edit the album name and album artist name of the tracks so they are the same. (For details on how to edit the information, refer to the Help of HDD Audio Remote.)
  - Edit the album name and album artist name of all music files you want to include together in same album so they are the same using music file management software on your computer, and then transfer (\*) those music files to the HDD AUDIO PLAYER.
  - Edit the album name and album artist name of all music files you want to include together in same album so they are the same using tag editing software on your computer, and then transfer (\*) those music files to the HDD AUDIO PLAYER. However, problems may occur in the music file management software if you are using that on your computer to edit.
- You can merge different albums into one album.

Select [Albums] from the Home screen, select the desired album, and then press and hold ENTER so that the Options menu appears. Select [Merge albums] from the Options menu, and then select the album you want to merge the album with. Albums belonging to the same folder are displayed as possible albums.
- Select [Folders] from the Home screen, select the desired folder, and then press and hold ENTER so that the Options menu appears. Select [Get music info] from the Options menu, and then select the information you want to obtain from the options displayed. Music files with the same album information will be recognized as tracks in the same album.

\* When you transfer music files the next time, the HAP Music Transfer transfers the changed files to the HDD AUDIO PLAYER again if it detects changes to the files in the folder you have selected.

---

## Tracks belonging to different albums are registered to one album.

---

- The album name and album artist name embedded in the music files are same on multiple albums.
  - Select the target album with HDD Audio Remote, and then edit the album name or album artist name of all music files you want to separate into different albums. (For details on how to edit the information, refer to the Help of HDD Audio Remote.)
  - Edit the album name or album artist name of all music files you want to separate into different albums using music file management software on your computer, and then transfer (\*) those music files to the HDD AUDIO PLAYER.
  - Edit the album name or album artist name of all music files you want to separate into different albums using tag editing software on your computer, and then transfer (\*) those music files to the

HDD AUDIO PLAYER. However, problems may occur in the music file management software if you are using that on your computer.

\* When you transfer music files the next time, the HAP Music Transfer transfers the changed files to the HDD AUDIO PLAYER again if it detects changes to the files in the folder you have selected.

---

The album art image displayed on the HDD AUDIO PLAYER is different from that displayed in the music file management software on your computer or does not display.

---

- Some music file management software may not embed album art images to music files. In this case, the album art image may be different from that displayed in the music file management software on your computer because the HDD AUDIO PLAYER obtains the album art image from the Gracenote database using tag information of the music file.
  - Select the target album with HDD Audio Remote, and then edit the album art image. (For details on how to edit the information, refer to the Help of HDD Audio Remote.)
  - Edit the album art images of all music files for which you want to change the album art image using tag editing software on your computer, and then transfer (\*) those music files to the HDD AUDIO PLAYER. However, problems may occur in the music file management software if you are using that on your computer.

\* When you transfer music files the next time, the HAP Music Transfer transfers the changed files to the HDD AUDIO PLAYER again if it detects changes to the files in the folder you have selected.

---

The track name or album name displayed on the HDD AUDIO PLAYER is different from that displayed in the music file management software on your computer or does not display.

---

- Some music file management software may not embed music information with some kinds of file formats such as WAV. In this case, the track name or album name may be different from that displayed in the music file management software on your computer because the HDD AUDIO PLAYER obtains the track name or album name from the Gracenote database using information of the music file other than the tag information.



- Select the target track or album with HDD Audio Remote, and then edit the track name or album name. (For details on how to edit the information, refer to the Help of HDD Audio Remote.)
- Edit the track name or album name of all music files for which you want to change the track name or album name using tag editing software on your computer, and then transfer (\*) those music files to the HDD AUDIO PLAYER. However, problems may occur in the music file management software if you are using that on your computer.

\* When you transfer music files the next time, the HAP Music Transfer transfers the changed files to the HDD AUDIO PLAYER again if it detects changes to the files in the folder you have selected.

---

When you attempt to obtain music information, merge albums or edit SensMe™ channels, an error message is displayed and you cannot perform the operation.

---

- You cannot obtain music information, merge albums or edit SensMe™ channels while  (the icon that indicates that a transfer or registration is in progress) is displayed. Perform the operation after this icon disappears from the display.
- You cannot obtain music information, merge albums or edit SensMe™ channels if  (the icon that indicates that a transfer or registration is in progress) is displayed after you start obtaining music information, merging albums or editing SensMe™ channels. Press the BACK button to cancel this operation, and then perform the operation again after this icon disappears from the display.

---

Cannot connect to Internet radio, or some stations or programs are interrupted at certain times of day.

---

- It may be difficult to connect to Internet radio because of server conditions or the time of day. Please try again later.

---

When operating TuneIn, [Current operation not available due to account restrictions.] appears.

---



- This may occur in rare situations, and is caused by the condition of the server. Wait for about a day and try again.

---

## Your computer cannot connect to the network after you press the WPS button.

---

- If you connect the HDD AUDIO PLAYER to the network using the WPS (Wi-Fi Protected Setup) function, the wireless settings of your wireless LAN router/access point may change automatically, and as a result, your computer may not be able to connect to the network.  
In this case, change the wireless settings of your computer accordingly.

---

## You cannot connect to the network or the network connection is unstable.

---

- Check that the wireless LAN router/access point is on.
- Check the network connection and the current network status in [Settings] - [Network Settings] - [View Network Status].
- Certain conditions in the usage environment, including certain wall materials, radio wave reception conditions, or obstructions between the HDD AUDIO PLAYER and the wireless LAN router/access point, may shorten the possible communication distance. Move the HDD AUDIO PLAYER and the wireless LAN router/access point closer to each other.
- Devices that use a 2.4 GHz frequency band, such as microwaves, Bluetooth, and digital cordless devices, may interrupt communication. Move the HDD AUDIO PLAYER away from such devices, or turn off such devices.
- The HDD AUDIO PLAYER is equipped with a built-in antenna for wireless LAN. Make sure to keep a distance between the HDD AUDIO PLAYER and speakers or other devices to maintain good wireless communication.

---

## The wireless router you want to connect to is not shown in the wireless network list.

- 
- Press the BACK button to return to the previous screen, and try [Select access point] again.  
If the wireless LAN router/access point you want is still not detected, select [Add a new access point.] from the network list to add a new wireless LAN router/access point.
  - The wireless LAN router/access point may be set to “stealth mode.” Confirm the setting of the wireless LAN router/access point and if the “stealth mode” is set to on, release the setting.

---

## It takes a long time to transfer and register music files to the HDD AUDIO PLAYER.

---

- We recommend using a wired LAN when you transfer music files stored on your computer to the HDD AUDIO PLAYER.
- When the HDD AUDIO PLAYER is connected to a computer through a wired LAN, file transfers will take the following time (as a rough guide):
  - 10 FLAC (44.1 kHz/16 bits) files: approximately 5 minutes
  - 3,000 FLAC (44.1 kHz/16 bits) files: approximately one day
- Transfer of music files via the network may be severely affected by conditions such as the router or other devices you are using, signal conditions in the area or the status of the HDD AUDIO PLAYER.
- Transfer and analysis of the music files are done in parallel by the HDD AUDIO PLAYER. Therefore, it may take some time before music file registration is completed.

---

## You want to turn off the Wi-Fi (wireless LAN) function but do not know how.

---

- Select [Wired Setup] in [Network Settings] – [Internet Settings]. Wired LAN is activated and the Wi-Fi (wireless LAN) function turns off. To re-activate the Wi-Fi (wireless LAN) function, select [Wireless Setup] in the [Internet Settings] menu.

---

## The external hard disk drive is not recognized.

- 
- The HDD AUDIO PLAYER is compatible with the ext4 and FAT file systems. If the external hard disk drive has a different file system, format it using the Format HDD function of the HDD AUDIO PLAYER. If you cannot format it, check the following:
    - Check that the USB cable used to connect the external hard disk drive is connected firmly and is not damaged. The connection may also become unstable depending on the type of USB cable being used. In this case, try another USB cable.
    - Turn off the HDD AUDIO PLAYER and then remove the external hard disk drive. Connect the external hard disk drive again and then turn on the HDD AUDIO PLAYER.
    - If the external hard disk drive is used with bus power, the connection may be unstable. In this case, use the external hard disk drive with an external power supply.
- 

## Some music files are not transferred.

---

- Transfer of music files may be cancelled because the hard disk drive you specified is full.
  - The audio file format may not be compatible with the HDD AUDIO PLAYER. Music files that have file extensions not supported by HAP Music Transfer or the HDD Audio Remote application installed on your smartphone or tablet cannot be transferred to the HDD AUDIO PLAYER.
  - The read attributes of some files or folders may be not permitted.
- 

## An external hard disk drive that has been used with the HDD AUDIO PLAYER cannot be used with your computer.

---

- The external hard disk drive that has been formatted by the HDD AUDIO PLAYER cannot be recognized by the computer.

If you want to use the external hard disk drive with your computer, format it on the computer. Please note that if you format the external hard disk drive with your computer, all stored music files will be erased.
-

# You want to delete music files but do not know how.

---

- You can delete music files from the HDD AUDIO PLAYER in the following ways.
    - Display the Options screen from the list screen or Playback screen and then select [Delete] to delete music files.
    - Use the HAP Music Transfer application installed on your computer to delete music files.
- 

# The information of an external hard disk drives does not appear on the HDD AUDIO PLAYER.

---

- External hard disk drives with compatible file systems need to be scanned when connected to the HDD AUDIO PLAYER for the first time. Confirm the message and then perform the scan. If the information on the external hard disk drive does not appear even after scanning the drive, try the following:
  - Select [Special Mode] - [Clear Database], and then rescan the hard disk drive.
  - If the problem still persists, perform [Factory Reset], and then rescan the hard disk drive. (\*)
- If you use a computer to add or delete music files on an external hard disk drive that was previously connected to the HDD AUDIO PLAYER, then connect the external hard disk drive to the HDD AUDIO PLAYER again, the information does not appear correctly. Try the following:
  - Perform [Rescan External HDD (differing items)].
  - If rescanning for differing items is not effective, perform [Rescan External HDD].
  - If the above two methods do not solve the problem, select [Special Mode] - [Clear Database], and then rescan the hard disk drive.
  - If the problem still persists, perform [Factory Reset], and then rescan the hard disk drive. (\*)

\* If you perform the Factory Reset function, all settings you have configured and all of the content stored on the internal hard disk drive will also be deleted.

---

[Unformatted external HDD has been connected. Format the HDD?] appears when you connect an external hard disk drive to the EXT port on the rear panel of the HDD AUDIO PLAYER.

---

- You are connecting an external hard disk drive that has a file system which is not supported by the HDD AUDIO PLAYER. You cannot play music files stored on the external hard disk drive.

Any music files stored on the external hard disk drive will be deleted if you format the external hard disk drive using the HDD AUDIO PLAYER. Also, you won't be able to use the external hard disk drive with other devices such as a computer, because the external hard disk drive (USB storage) is formatted only for the HDD AUDIO PLAYER.

---

## Using the Clear Database function or the Reset to Default Settings function (Special Mode)

---

If a problem with the HDD AUDIO PLAYER cannot be solved using the troubleshooting instructions, you can perform the [Special Mode] function.

1. During standby mode, press  while pressing HOME.  
The Special Mode screen appears.
2. Select [Clear Database] or [Reset to Default Settings].  
After [Clear Database] or [Reset to Default Settings] is completed, restart the HDD AUDIO PLAYER according to the instructions that appear in the display.

### Details of displayed items

#### Clear Database:

This function clears the registered information but does not format the hard disk drive. After the database is cleared, rescan the hard disk drive. Although the hard disk drive may seem to be empty after the database is cleared, the content (music data) still remains on the hard disk drive. Rescan the hard disk drive to restore and display the content information.

#### Reset to Default Settings:

This function resets all the settings and restores the factory default settings.

#### Restart:

This function exits the Special Mode and restarts the HDD AUDIO PLAYER.

---

## Resetting to the factory default

---

If you can still not solve defects of the HDD AUDIO PLAYER, you can perform the Factory Reset function.

We recommend making a backup of all your data before performing the Factory Reset function.

---

## Customer support websites

---

Please access the following support websites for information on your HDD AUDIO PLAYER.

**For customers in the USA:**

<http://esupport.sony.com/>

**For customers in Canada:**

<http://esupport.sony.com/CA/>

**For customers in Europe:**

[www.sony.eu/support](http://www.sony.eu/support)